



Zenith CH801

white version 1:33 scale

spinner 43

air scoop 39 40

38

30 29

42 shaft hub

32

34

enigne plate 76

stiffener 35

enigne shaft

36

31

cowling

fairing

windscreen 53

23 former

25 stiffener

27

89 angles

54 windscreen struts

86 87

21 fuselage

41 exhausts

88 enforcement bars

22 fuselage bottom

firewall glue strip

33 cowling glue strips

51 horizontal stabilizer tips

48 Tail

49 Tailtop

50 horizontal stabilizer

52 Tail LEX

model designed by Christoph Stahl 01-2012
©stahlhart productions

STAHLHART Papercraft
<http://www.hoxity.de/papercraft>

inner wing structure

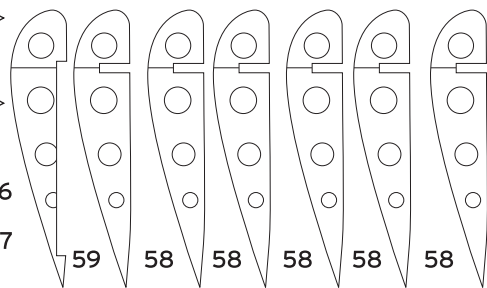
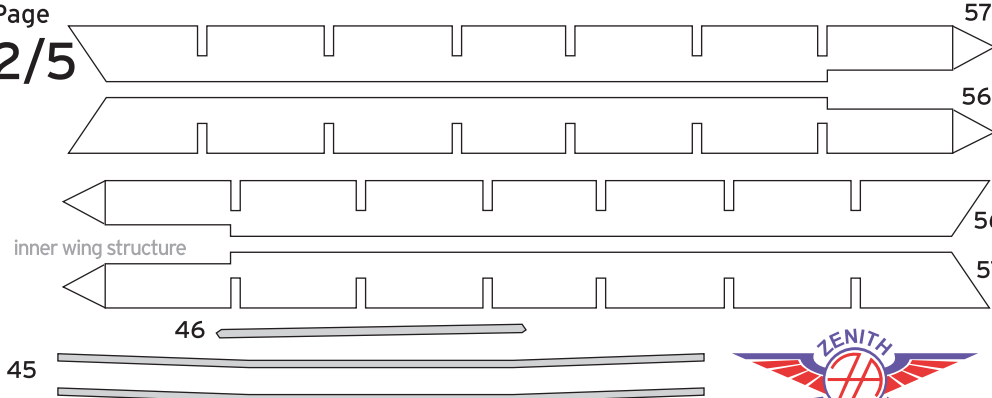

model designed by Christoph Stahl 01-2012
©stahlhart-productions

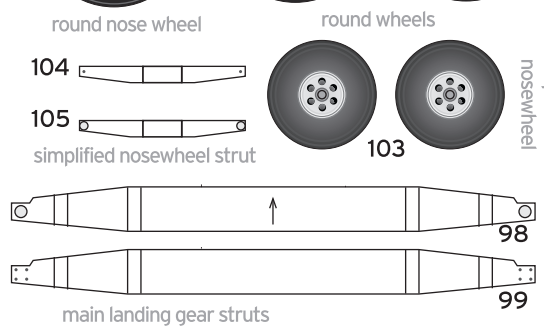
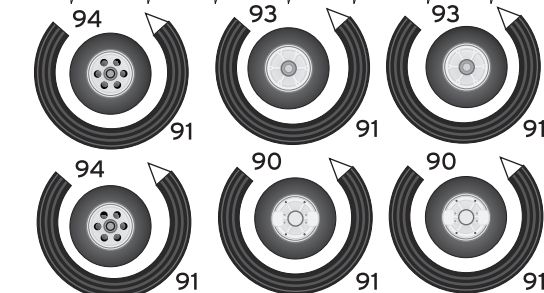
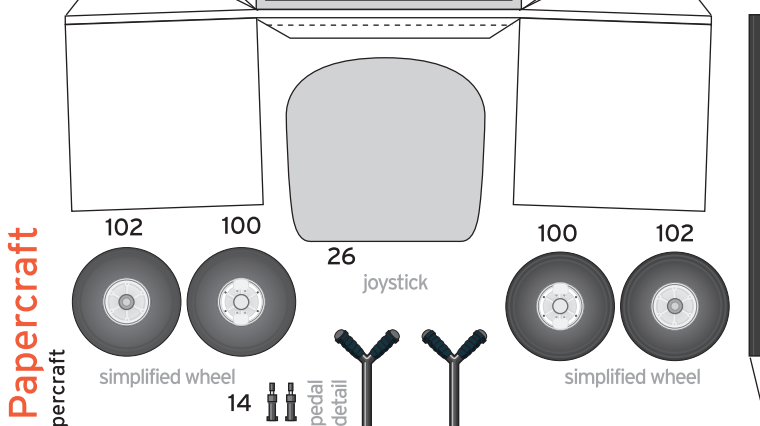
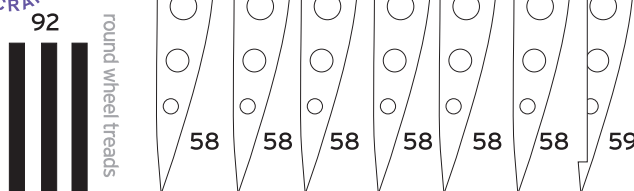
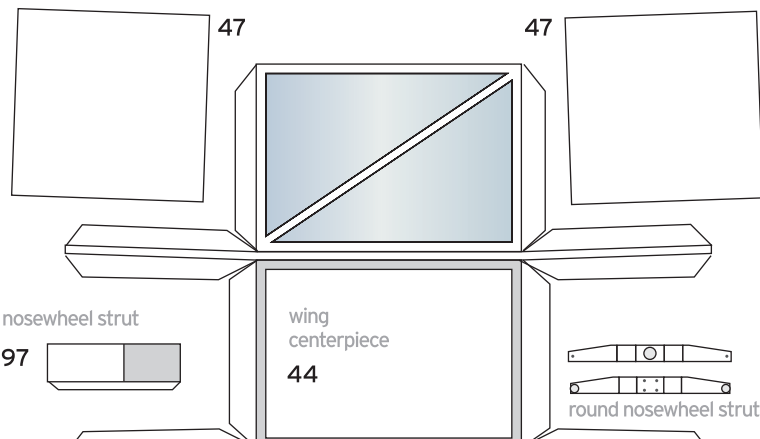

STAHLHART Papercraft
<http://www.hoxity.de/papercraft>

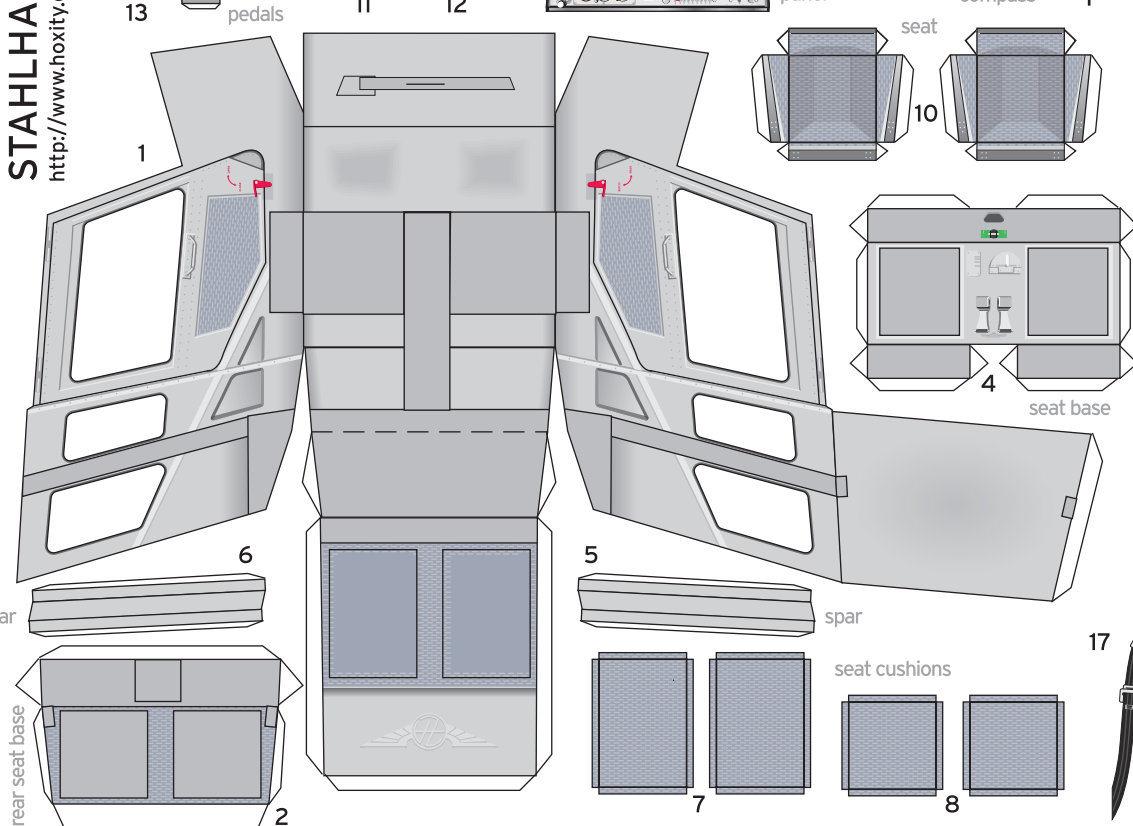

Zenith
CH
801

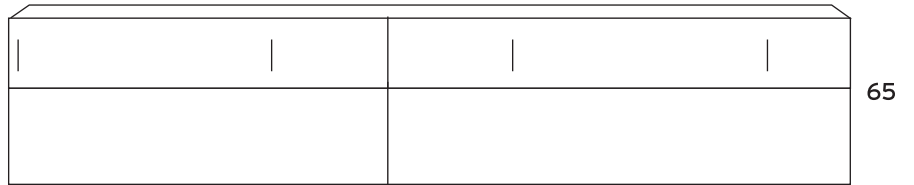
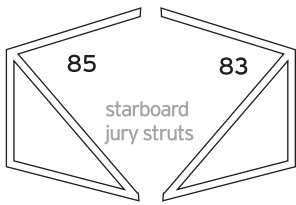

starboard wing struts

Zenith CH 801

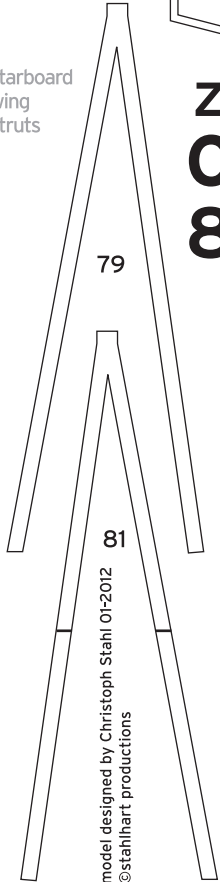

model designed by Christoph Stahl 01-2012
©stahlhart productions

starboard wingtip

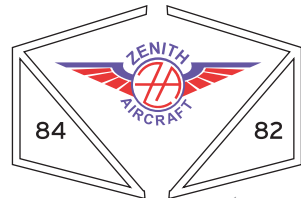
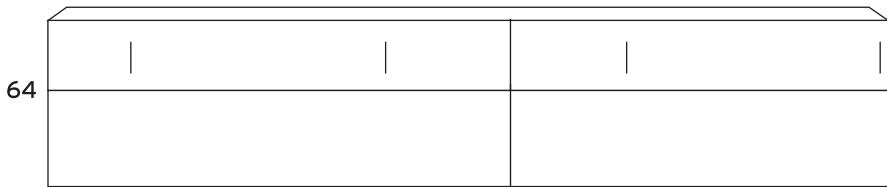
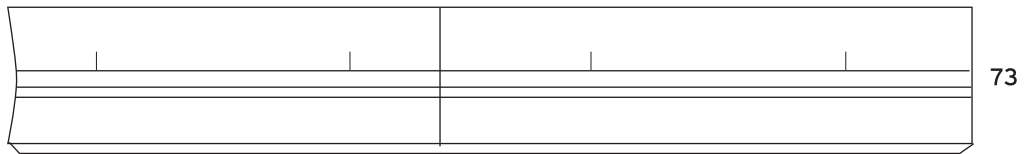
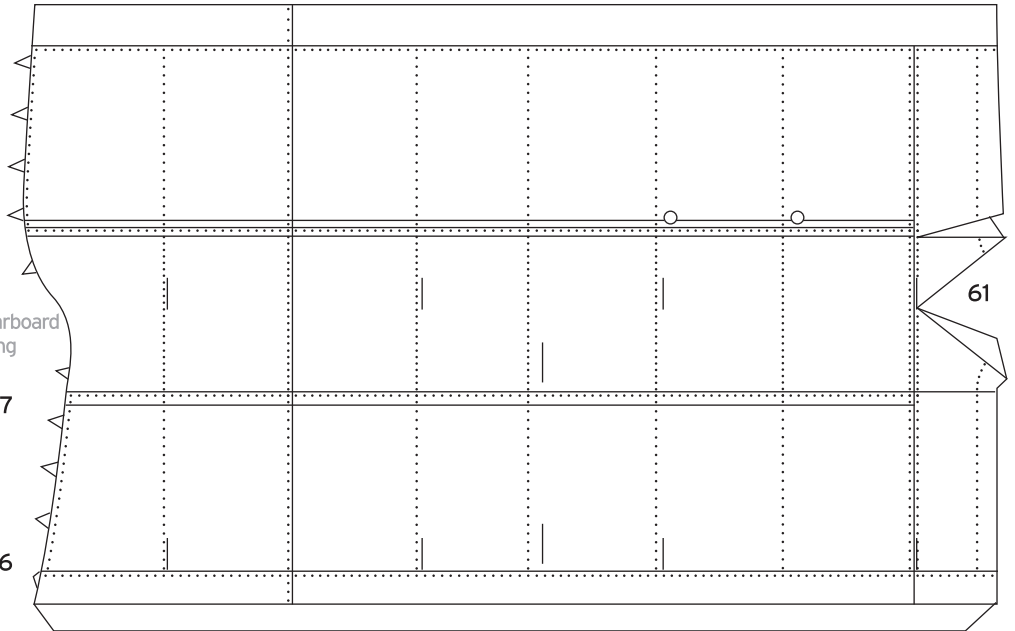
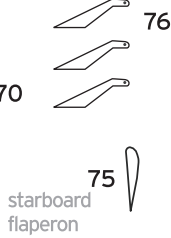
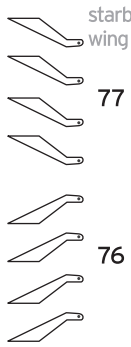

port jury struts

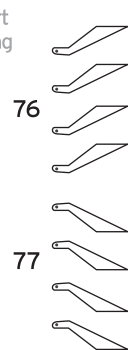
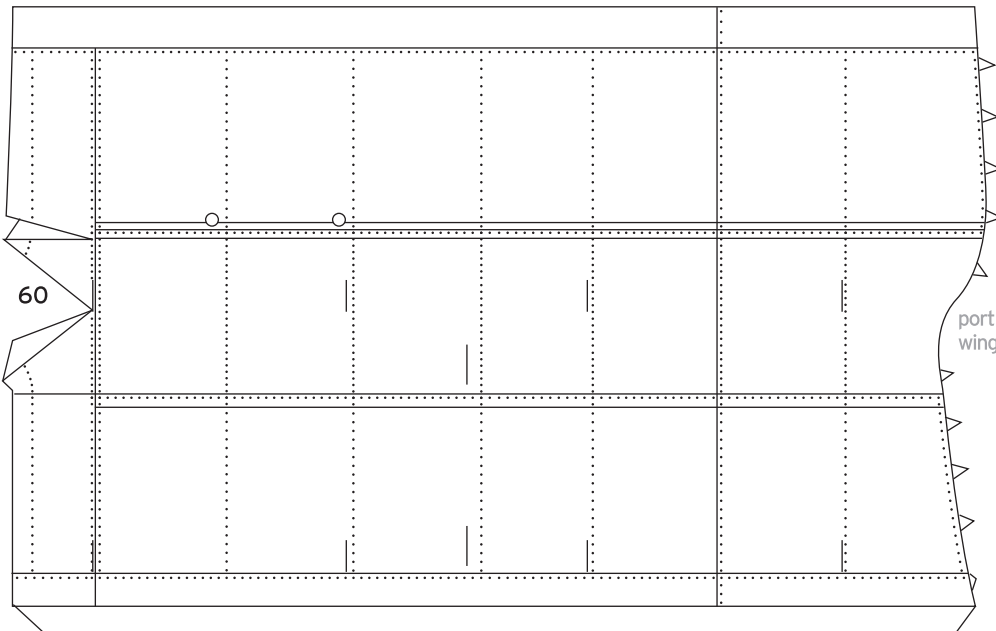

port flaperon

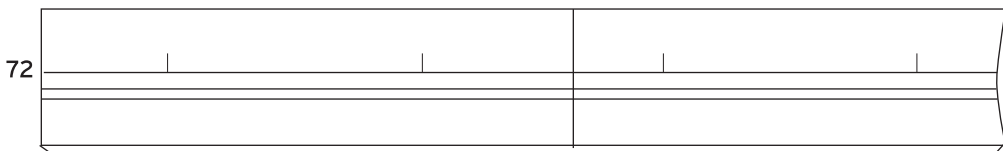
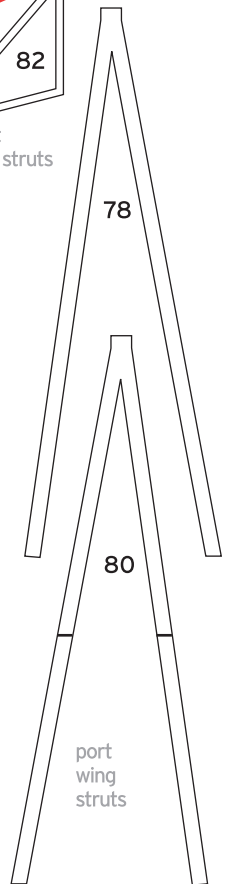

Zenair Float 2200A for the CH801



STAHLHART Papercraft
<http://www.hoxity.de/papercraft>

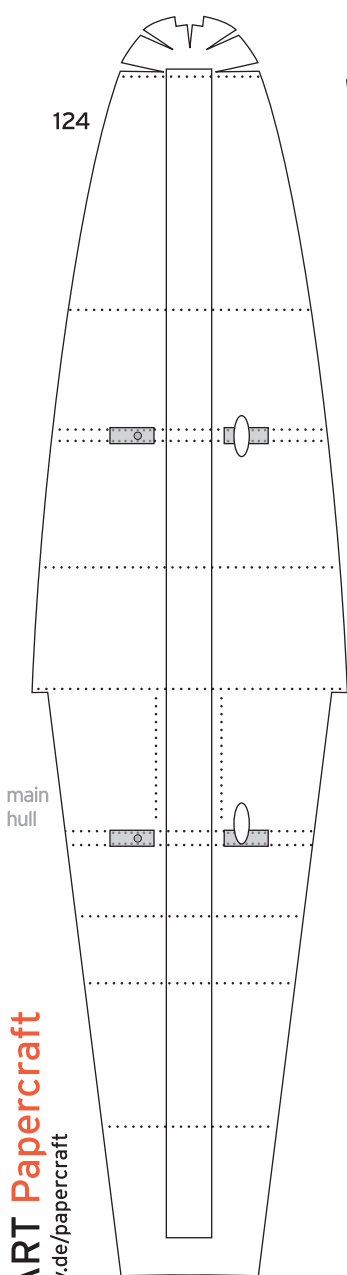
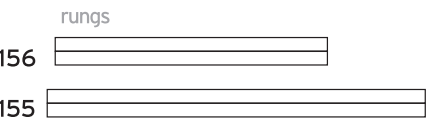

main hull

horizontal struts

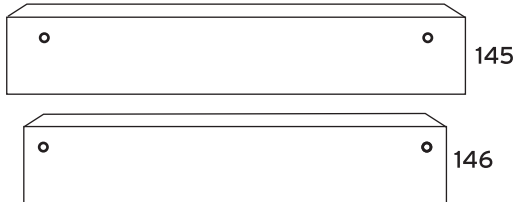

main landing gear struts (up)

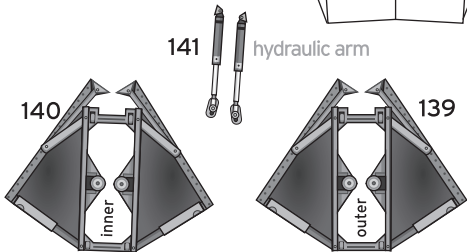

141 hydraulic arm

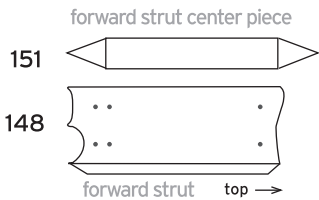

forward strut center piece

forward strut top →

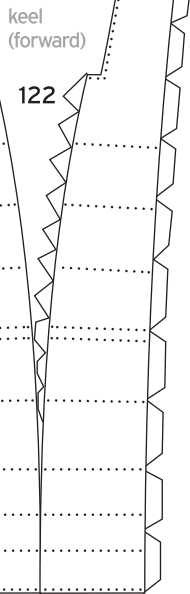

keel (forward)

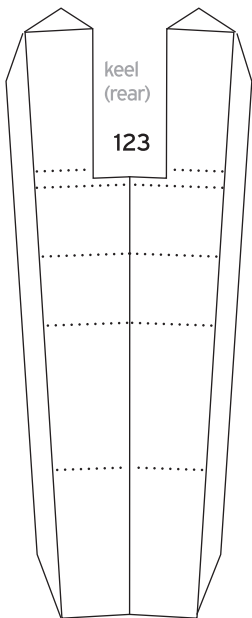

keel (rear)

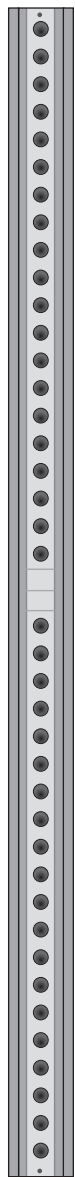

125 top rail

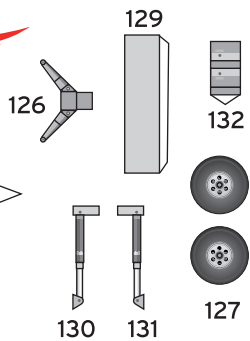

bulkeahds (formers)

bulkeahds (formers)

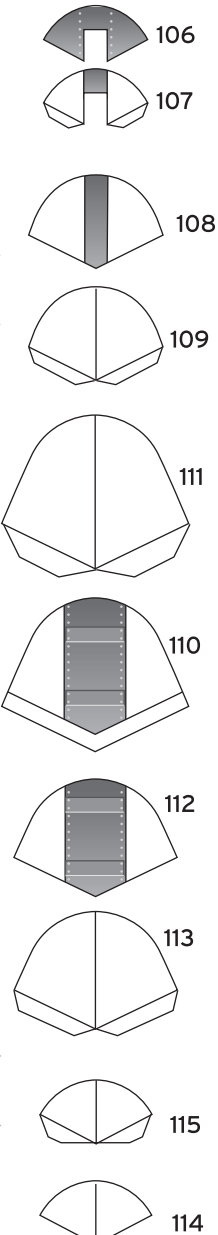

model designed by Christoph Stahl 01-2012 ©stahlhart productions

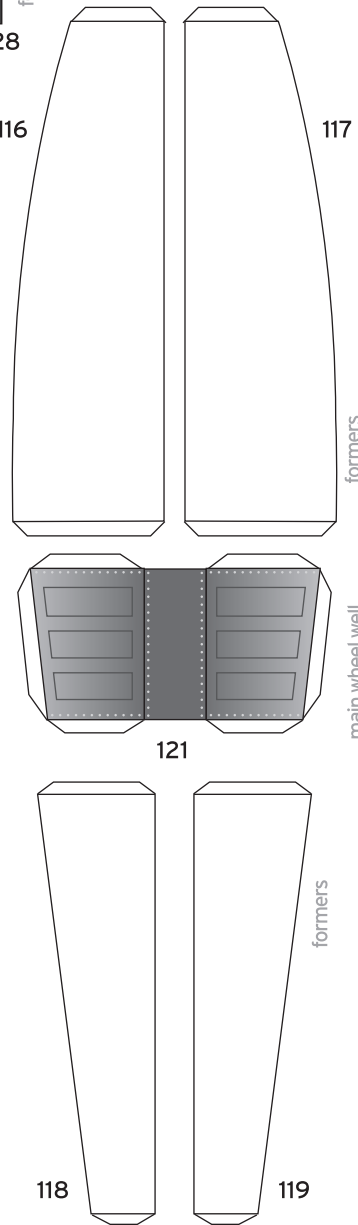

forward wheel well

formers

formers

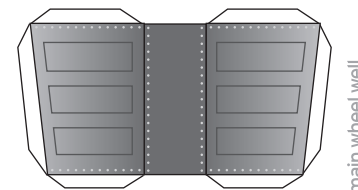

main wheel well

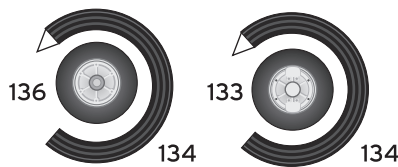

135 main landing gear wheel

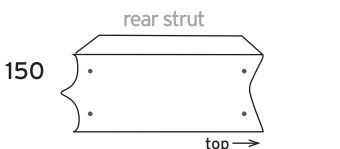

rear strut

top →

← rear

diagonal strut

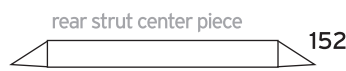

rudder anchoring

rudder

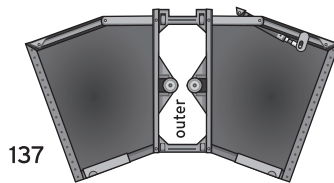

main landing gear struts (down)

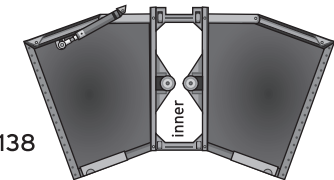

Zenair Float 2200A for the CH801

model designed by Christoph Stahl 01-2012
©stahlhart productions

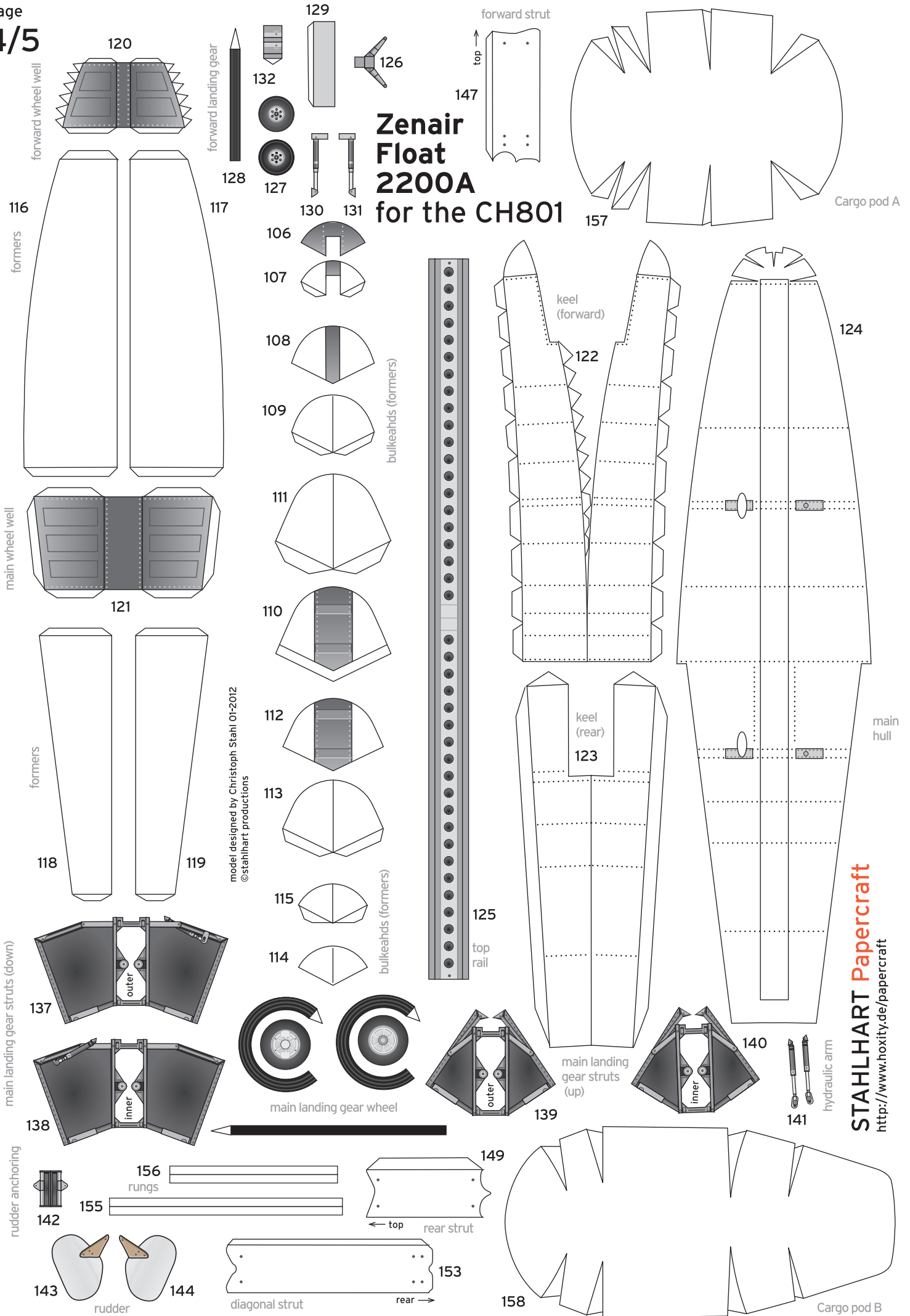

STAHLHART Papercraft
<http://www.hoxity.de/papercraft>