

spinner

1:33 scale

Zenith CH801

Medicine on the Move, Ghana

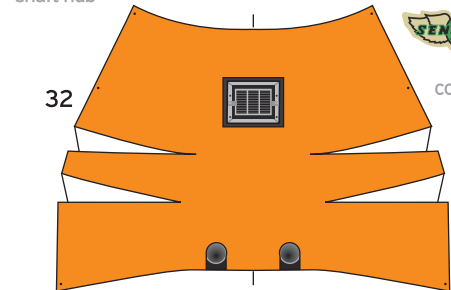
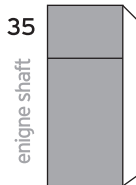
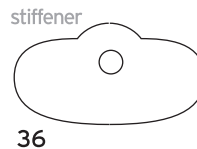
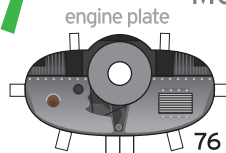
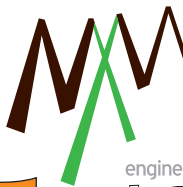
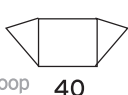
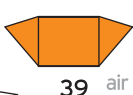
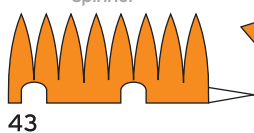

cowling

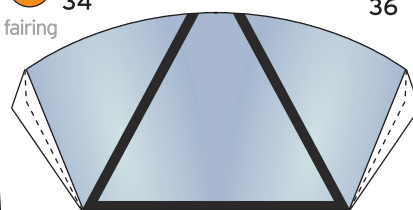
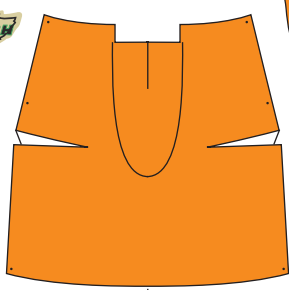

windscreen 53

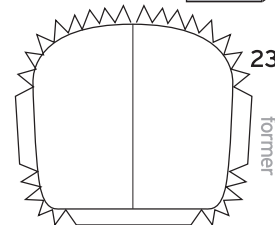

formers

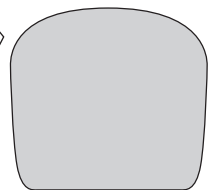

stiffener

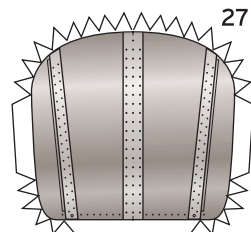

27

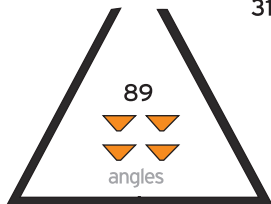

54 windscreen struts



angles



86



87

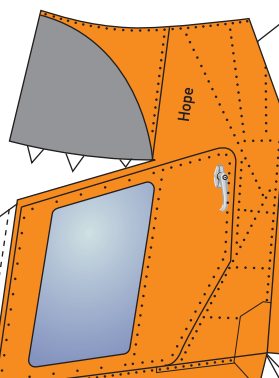

21 fuselage



41

exhausts



88

enforcement bars

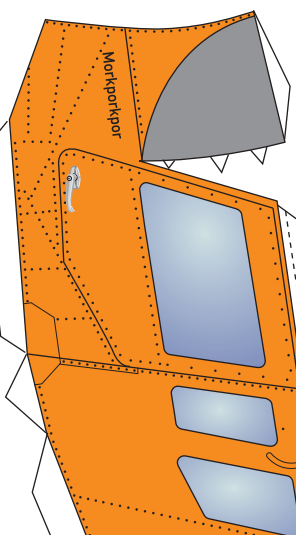

22 fuselage bottom

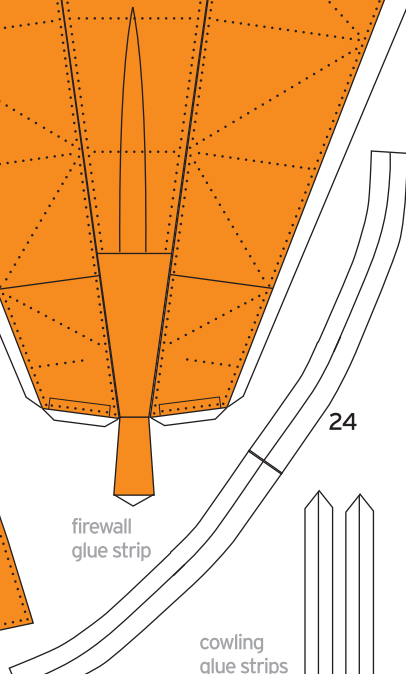

firewall glue strip

cowling glue strips

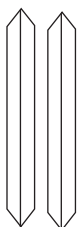

33

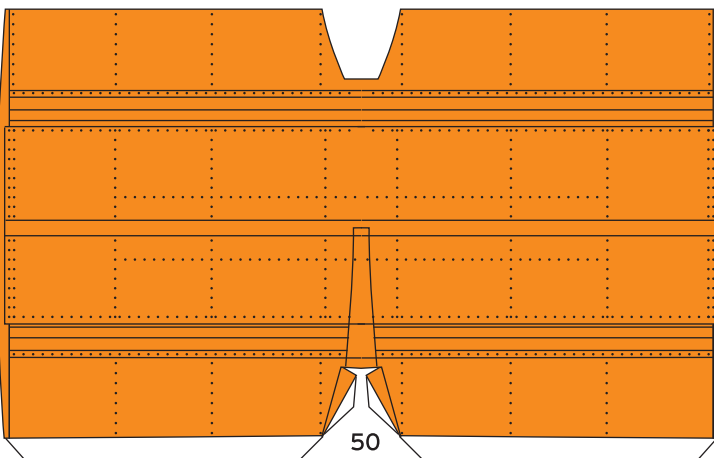

horizontal stabilizer



horizontal stabilizer tips

51



Tail

48

WOW 96

WOW 96

49

Tailtip



Tail 52
LEX

inner wing structure

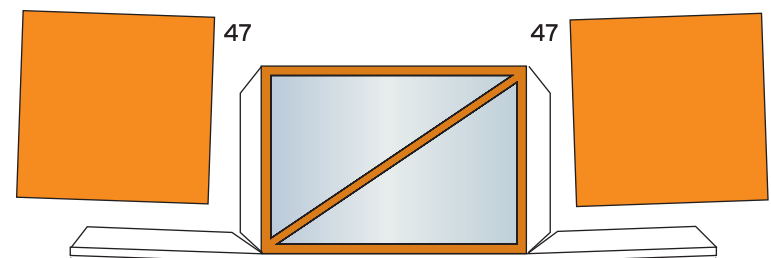

nosewheel strut



wing centerpiece

44

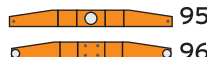

round nosewheel strut

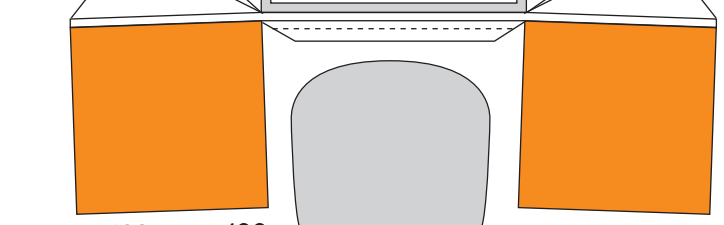

102

100

26

100

102

joystick

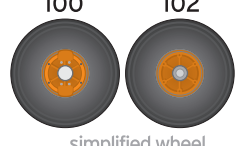

simplified wheel

simplified wheel



11

12

pedal detail

14



13

pedals



panel

101



compass

55



model designed by Christoph Stahl 01-2012
©stahlhart productions
licensed to Medicine On The Move



round wheel treads



simplified wheel treads

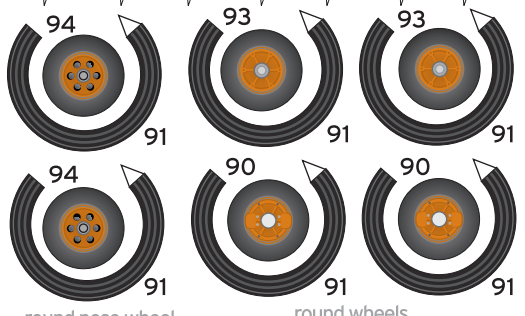

round nose wheel

round wheels

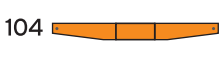

simplified nosewheel strut

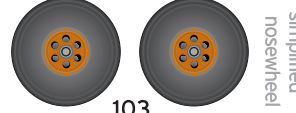

simplified nosewheel

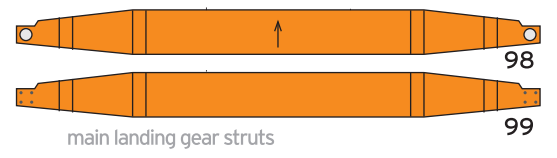

main landing gear struts



Use this as a reference
to bend the landing gear struts

STAHLHART Papercraft
<http://www.hoxity.de/papercraft>

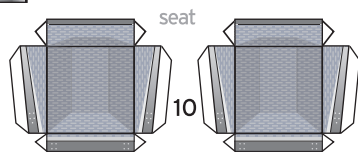
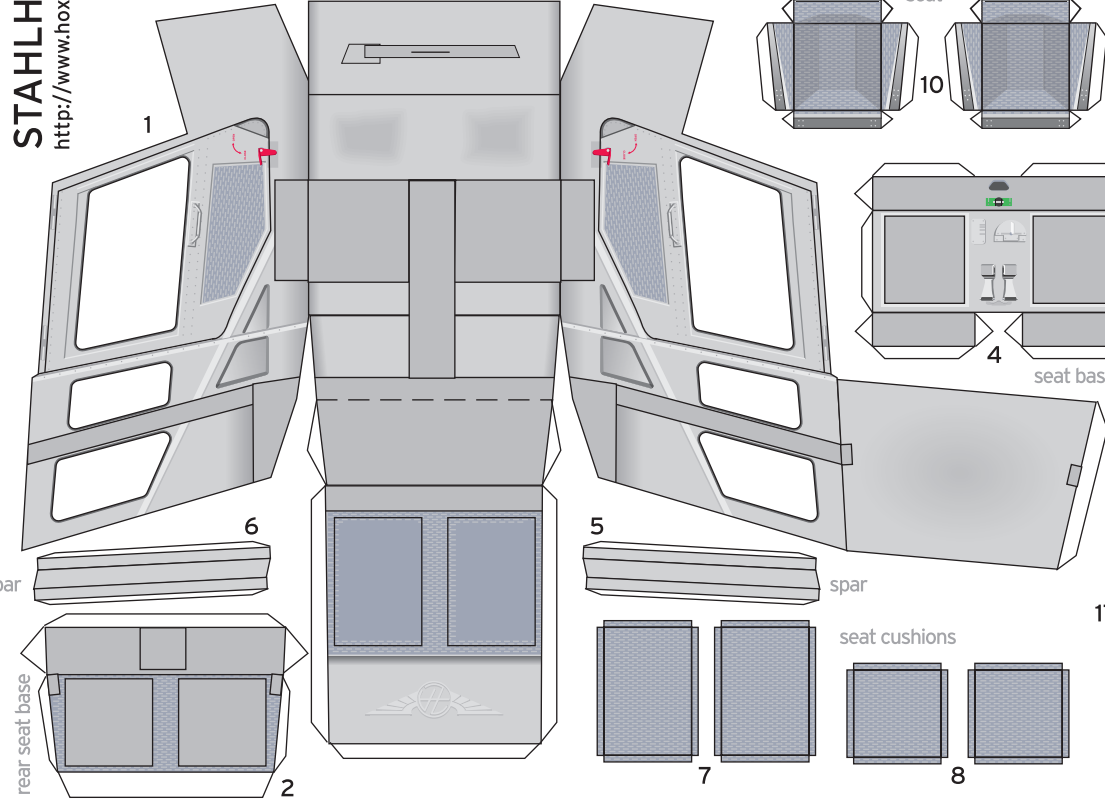

seat

10

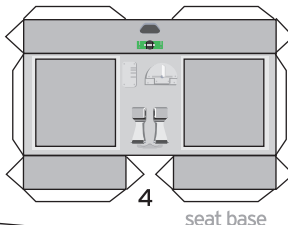

seat base

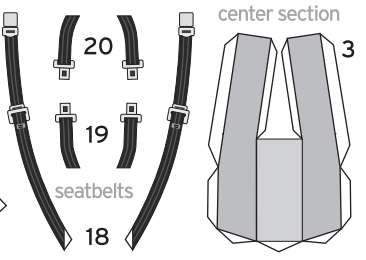

seatbelts

18

center section

3

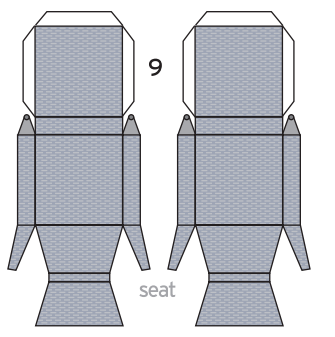

seat

9

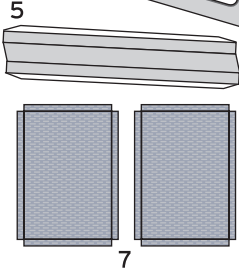

seat cushions

7

8

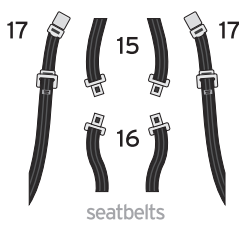

seatbelts

Zenith
CH
801

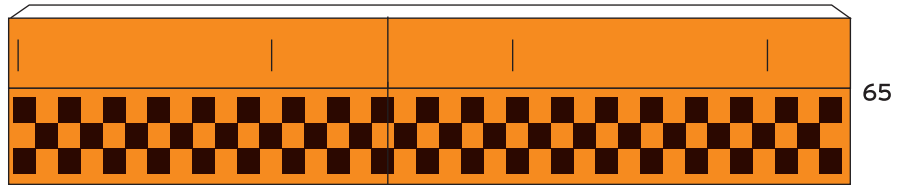
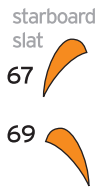
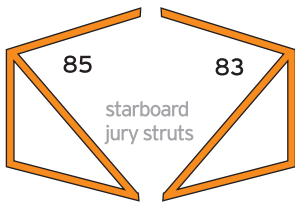

starboard wing struts

Zenith CH 801



starboard wingtip

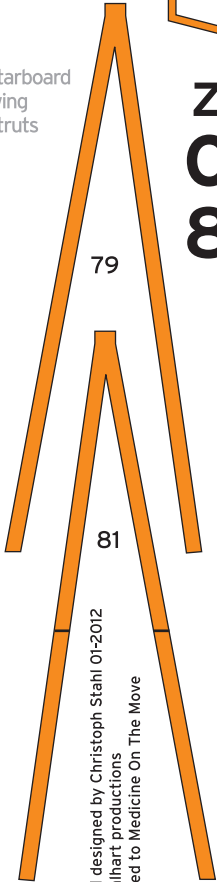

model designed by Christoph Stahl 01-2012
©stahlhart productions
licensed to Medicine On The Move



brackets

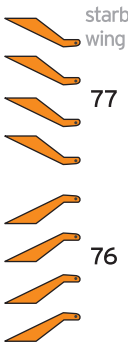

starboard wing



starboard flaperon

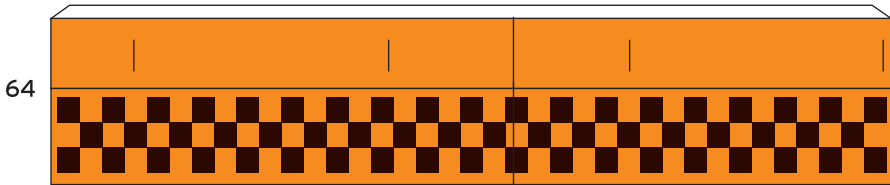
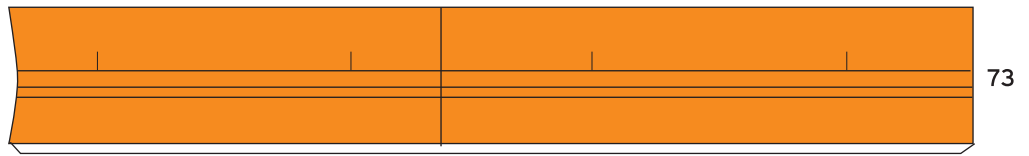
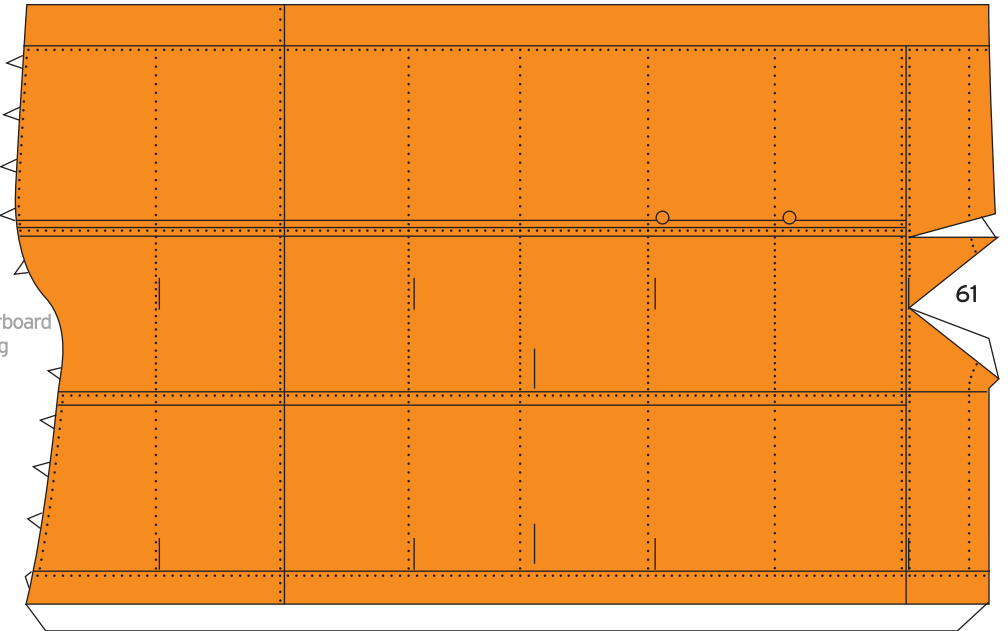

port slat



port jury struts

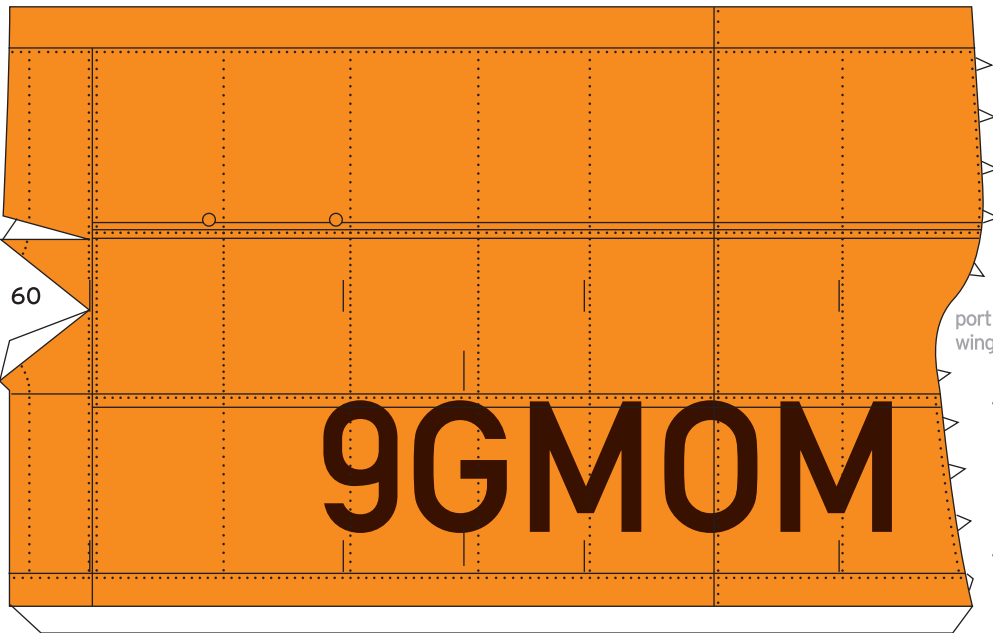

port wing tip



brackets

port wing

76

77



port flaperon

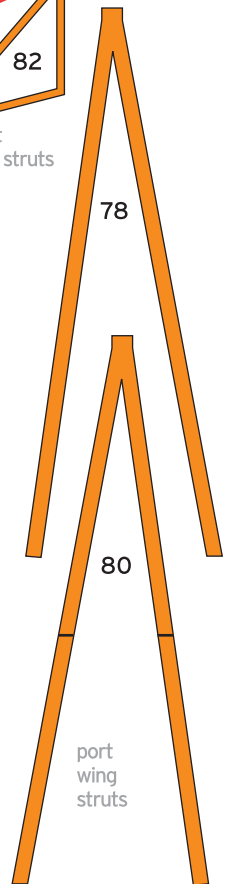

78

80

port wing struts

9GMOM

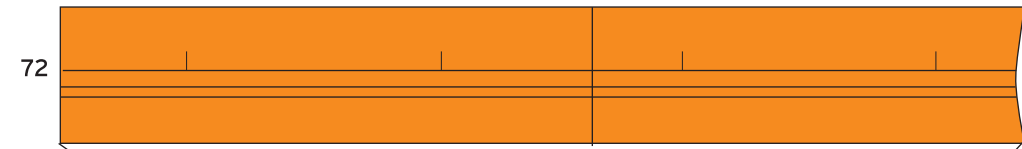

Zenair Float 2200A for the CH801



forward strut center piece



forward strut top →

rungs



124

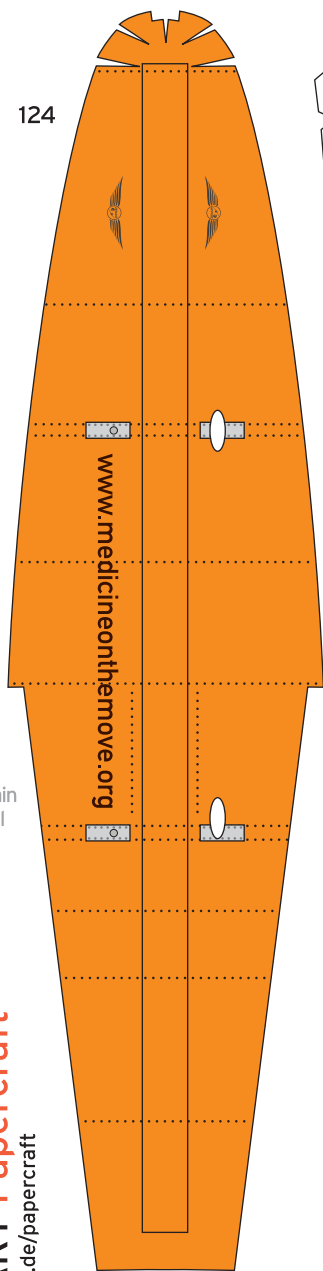

keel (forward)

122

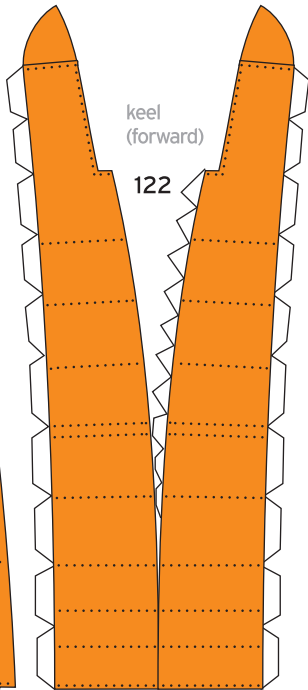

keel (rear)

123

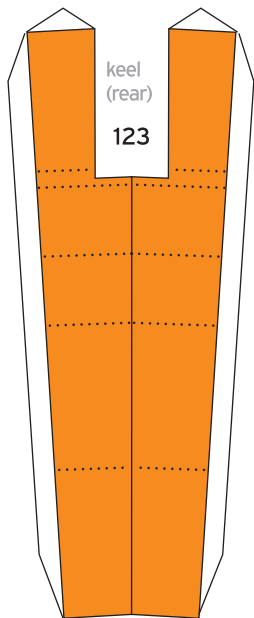

main hull

www.medicinethemove.org

STAHLHART Papercraft
http://www.hoxity.de/papercraft

141 hydraulic arm



140

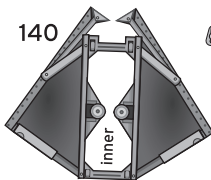

139

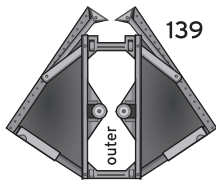

main landing gear struts (up)



145



146

horizontal struts

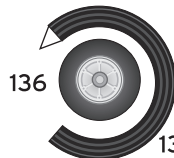

135 main landing gear wheel

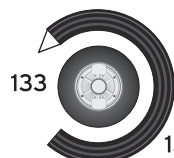

134

rear strut

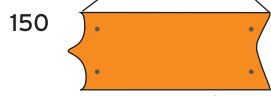

← rear diagonal strut

rear strut center piece



rudder anchoring

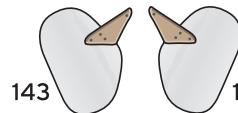

rudder

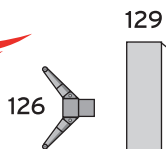

126

129



132



127



130

131



106

107

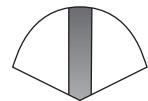

108

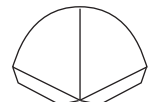

109

bulkeahds (formers)

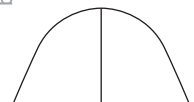

111

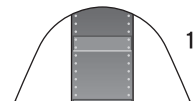

110

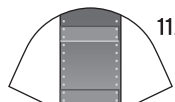

112

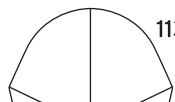

113

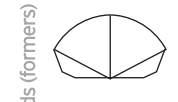

115



114

bulkeahds (formers)

125

top rail

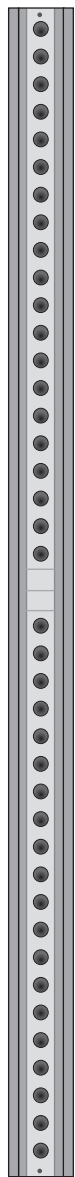

128

116

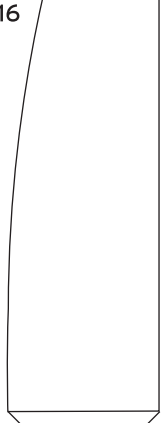

forward wheel well

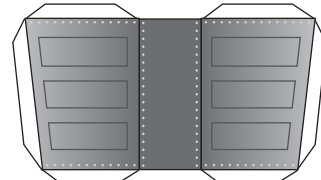

121

formers

main wheel well

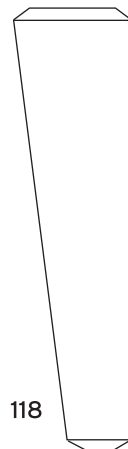

118

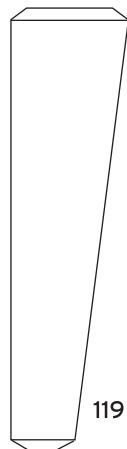

119

formers

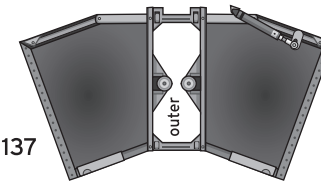

137

main landing gear struts (down)

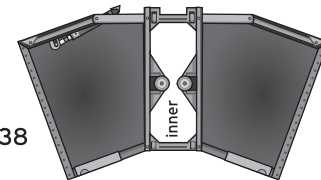

138

model designed by Christoph Stahl 01-2012
©stahlhart productions
licensed to Medicine On The Move

Zenair Float 2200A for the CH801

forward wheel well 120

forward landing gear 126, 127, 128

129 forward strut

147 top

157 Cargo pod A

116 formers

117

106 107 108 109 110 111 112 113 114 115 116 bulkheads (formers)

125 top rail

122 keel (forward)

123 keel (rear)

124 main hull

www.medicinetheMOVE.org

137 main landing gear struts (down)

138 main landing gear struts (up)

139 main landing gear wheel

140 141 hydraulic arm

142 143 144 rudder

145 146 147 148 149 rudder anchoring

150 151 152 153 154 155 156 157 158 diagonal strut rear

model designed by Christoph Stahl 01-2012
©stahlhart productions
licensed to Medicine On The Move

STAHLHART Papercraft
<http://www.hoxity.de/papercraft>