

^°îâ

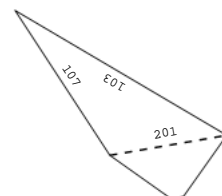

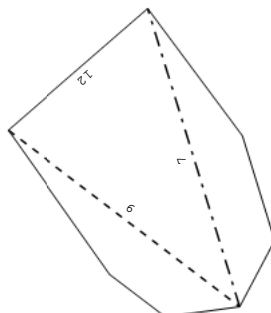

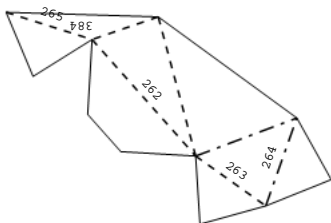

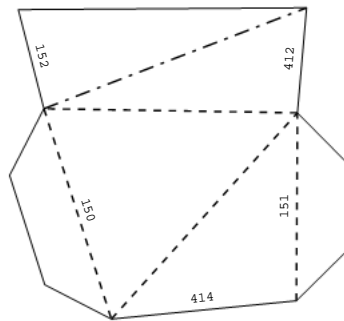
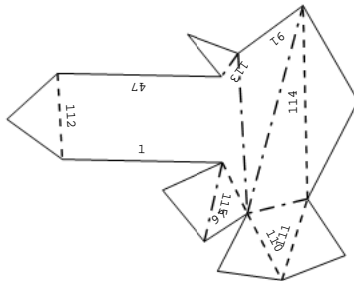
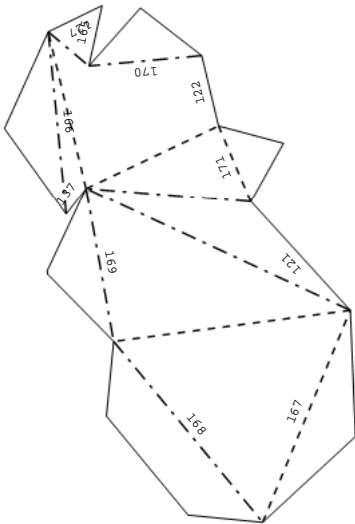
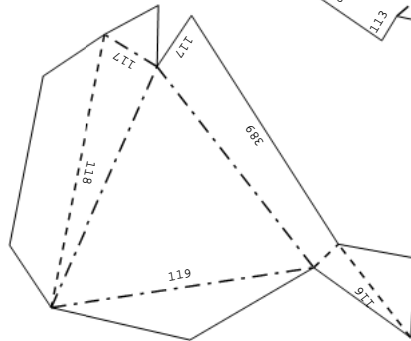
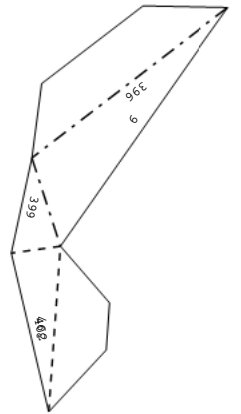
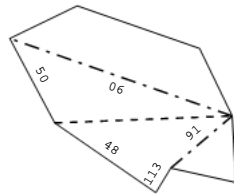
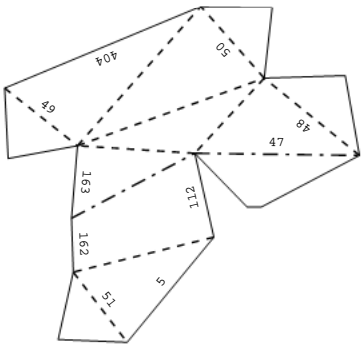
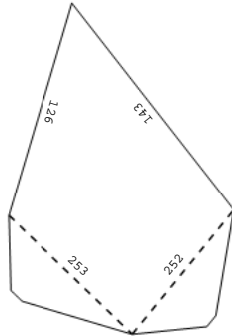
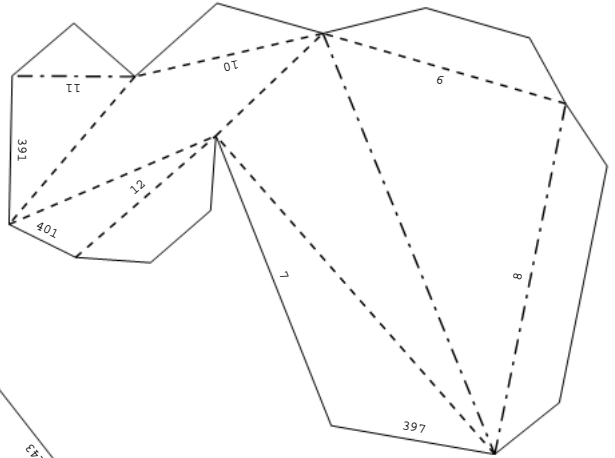
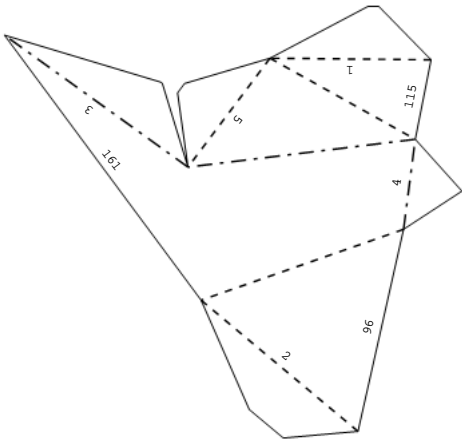
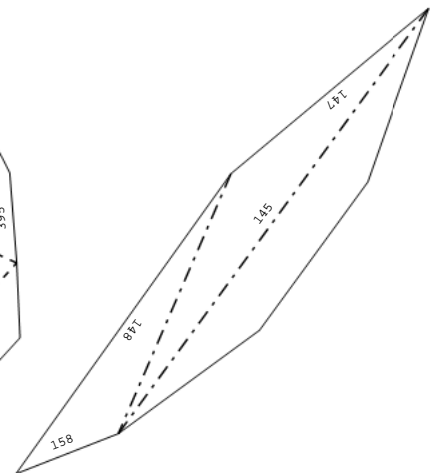
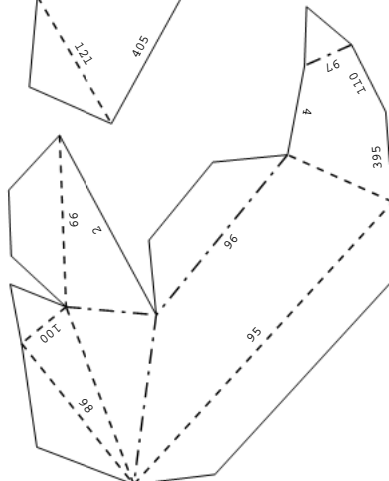
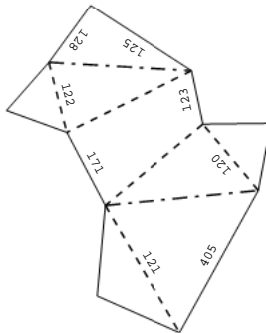
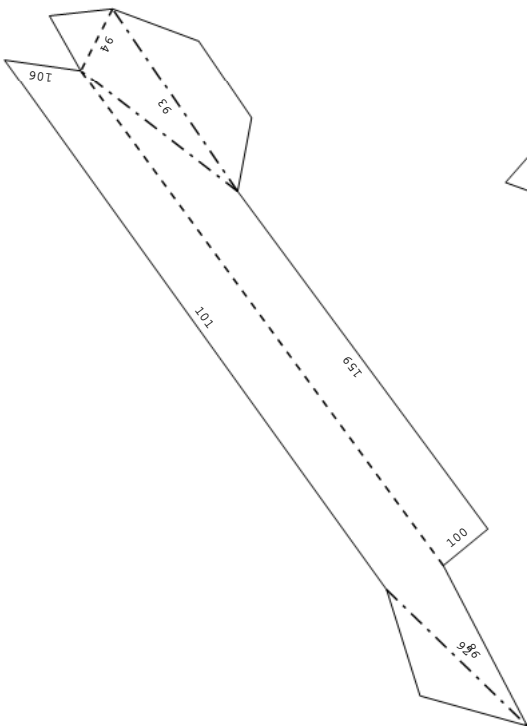
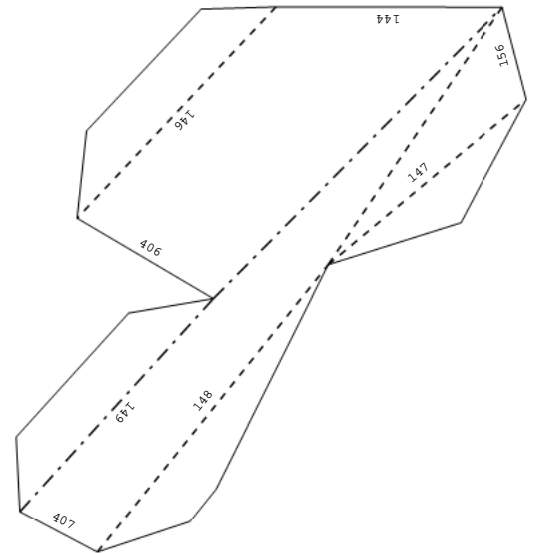
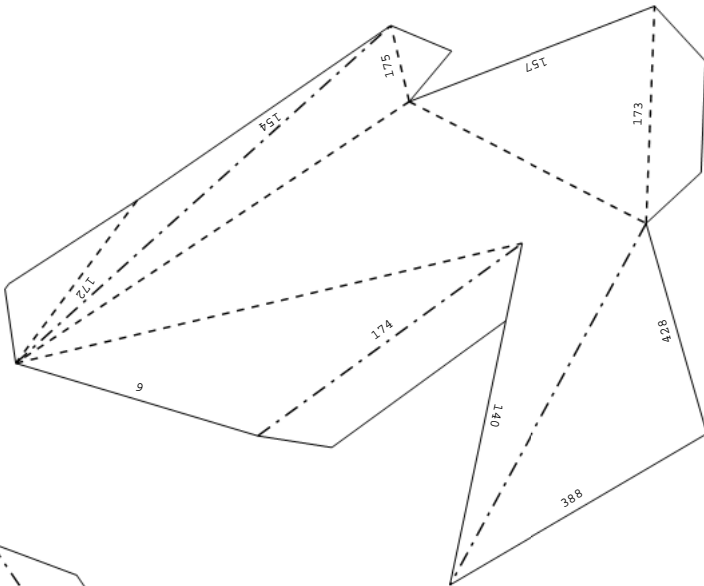
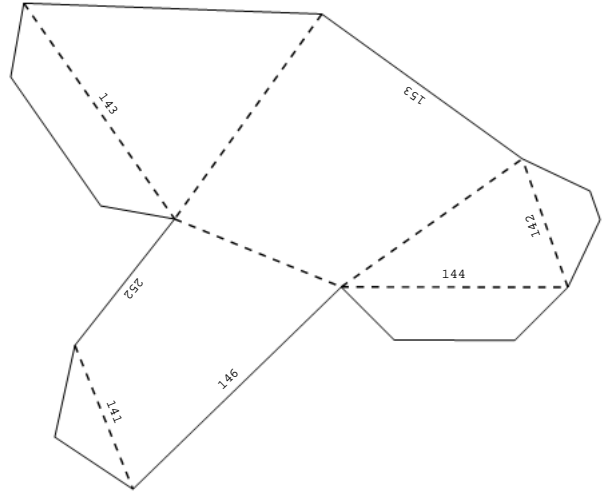
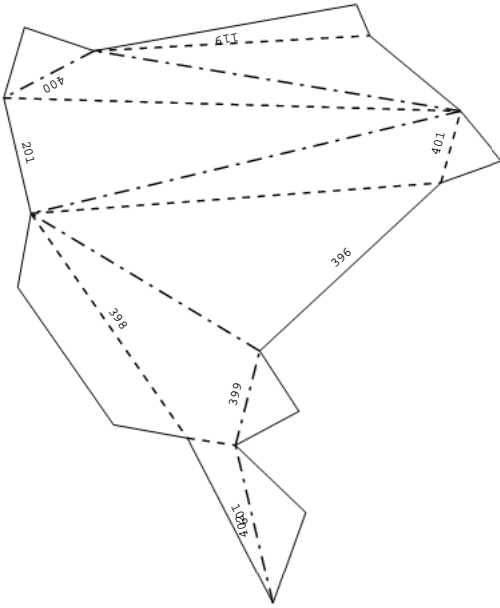
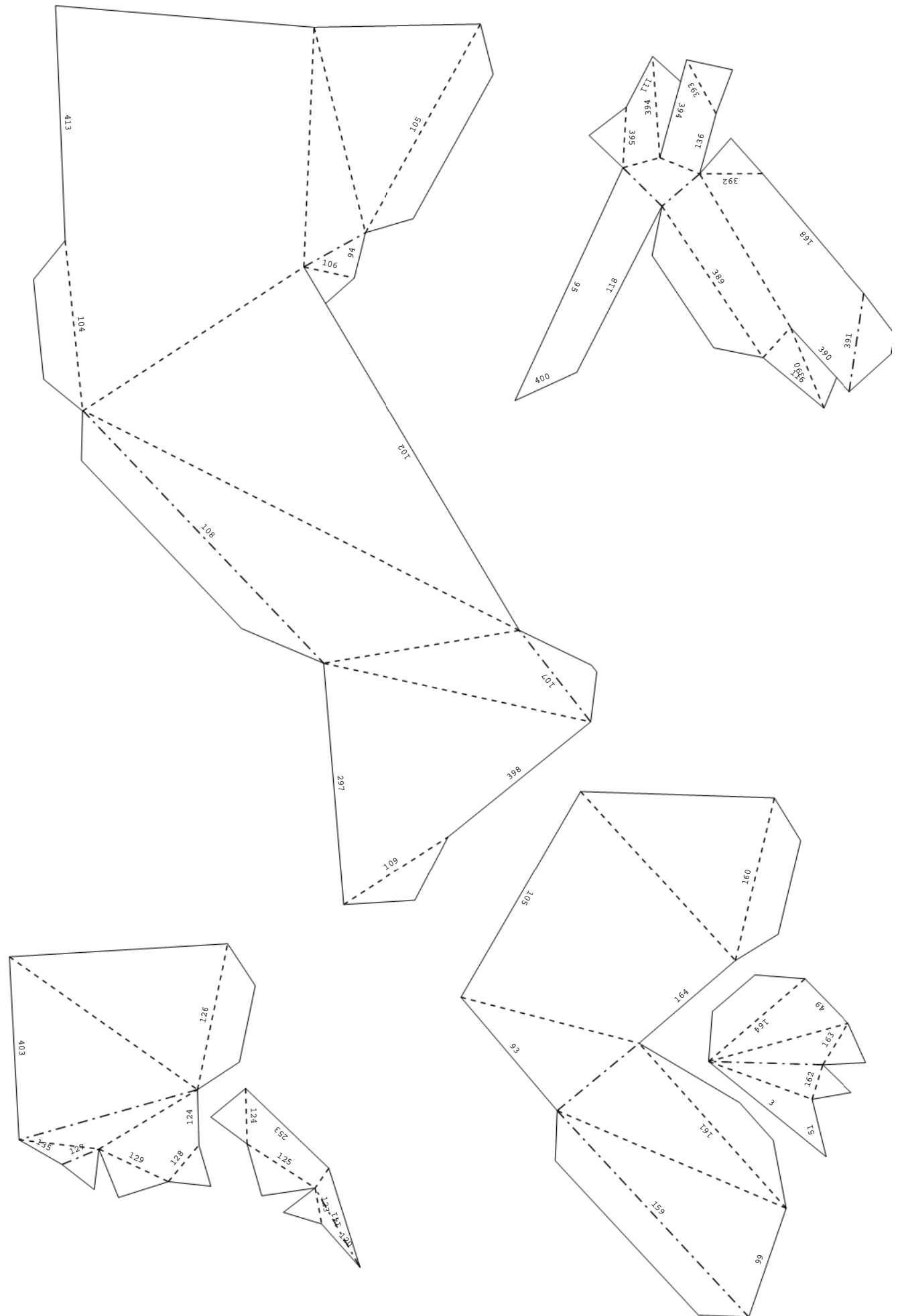
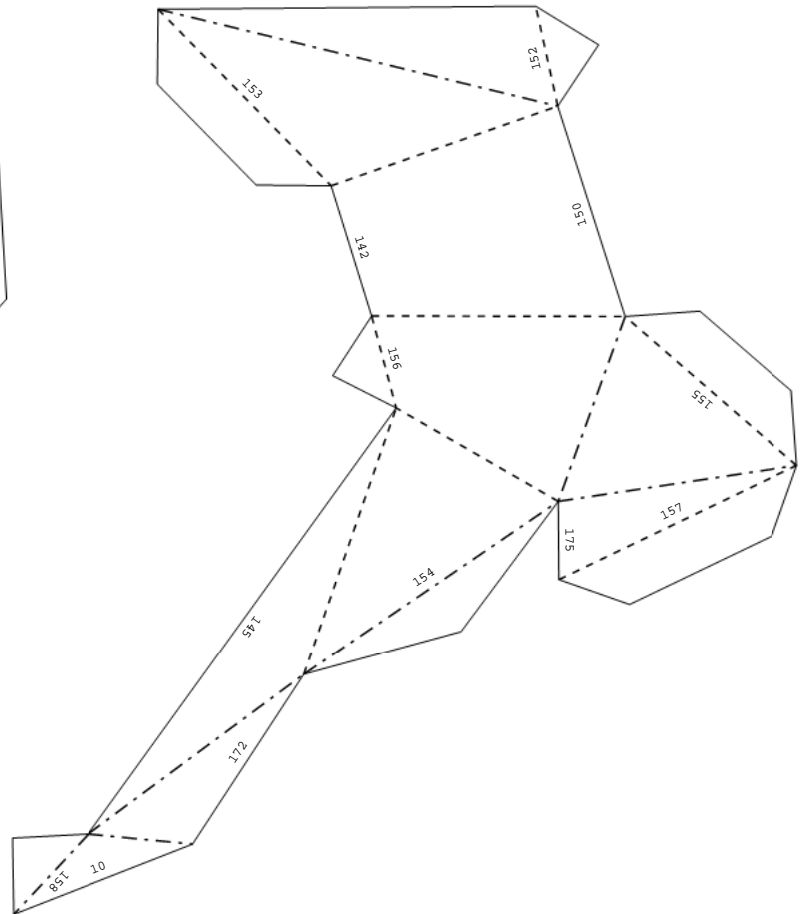
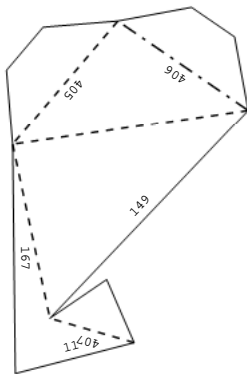
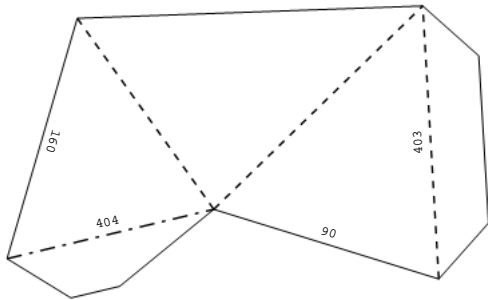
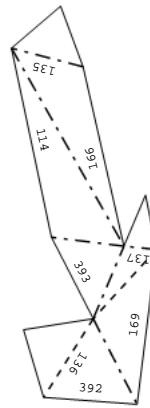
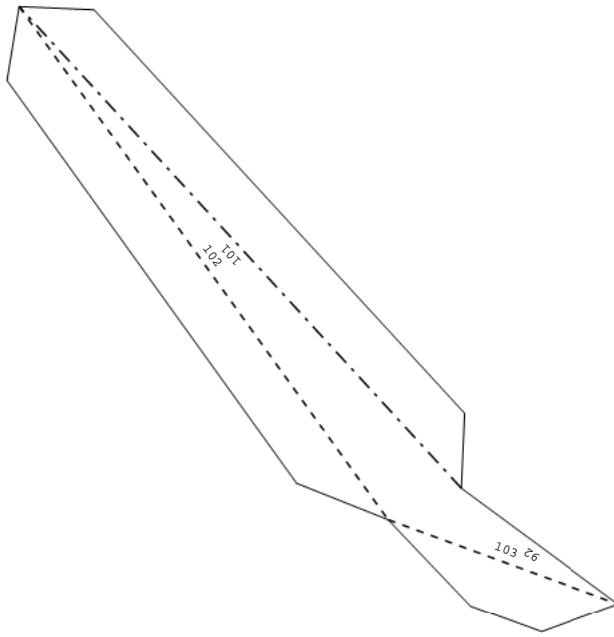

aj

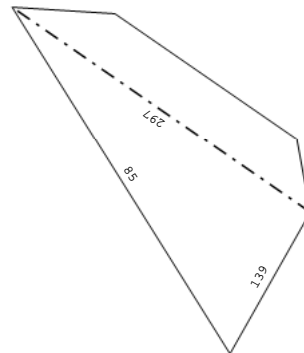
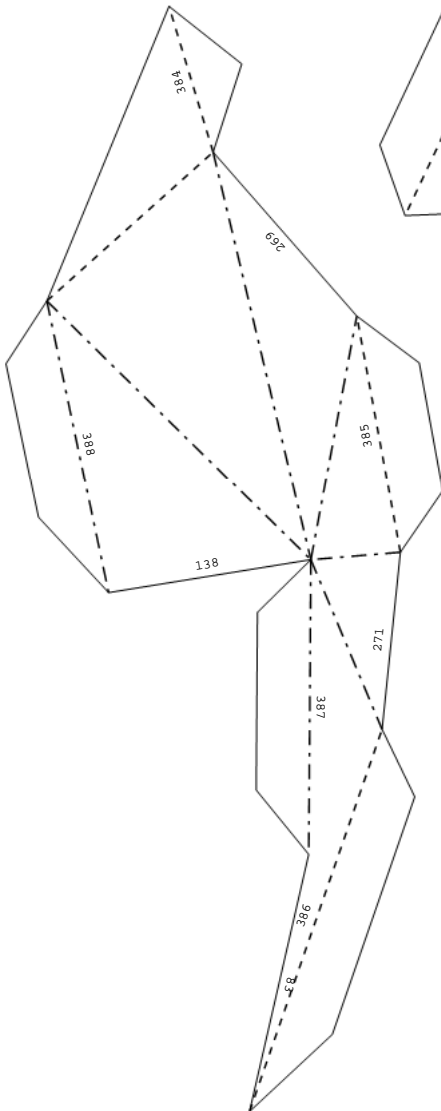
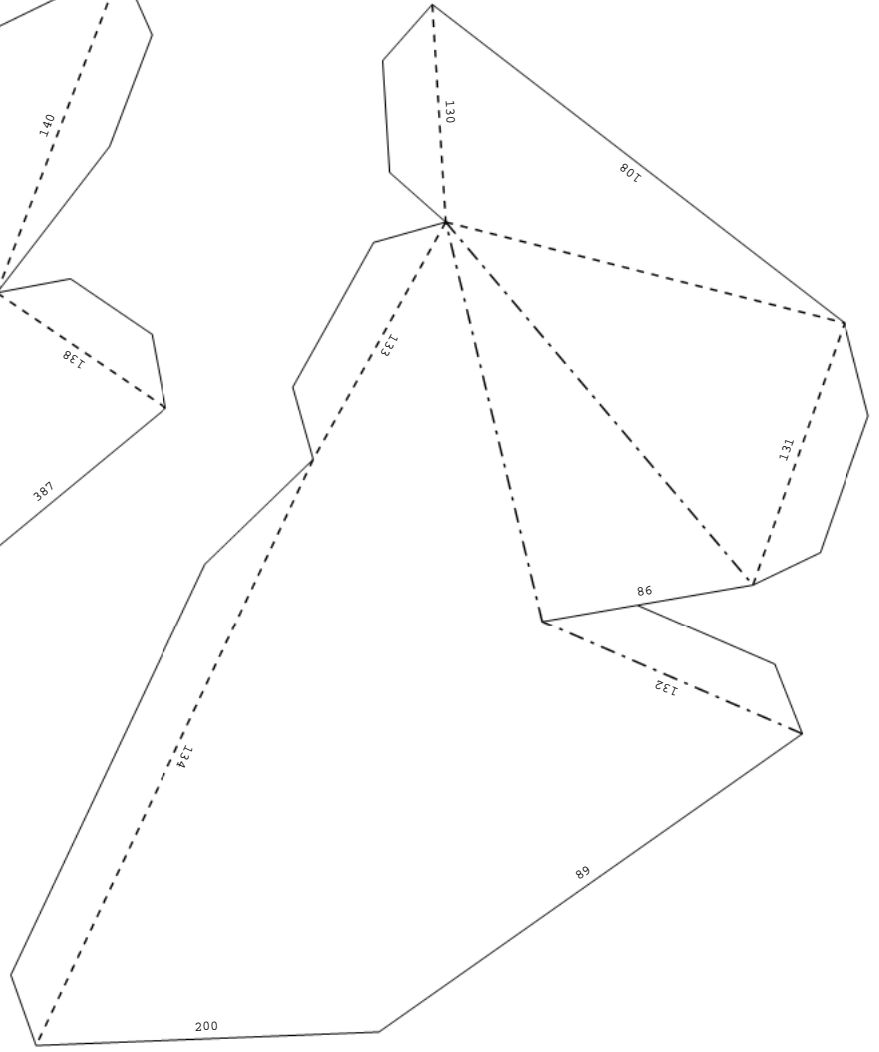
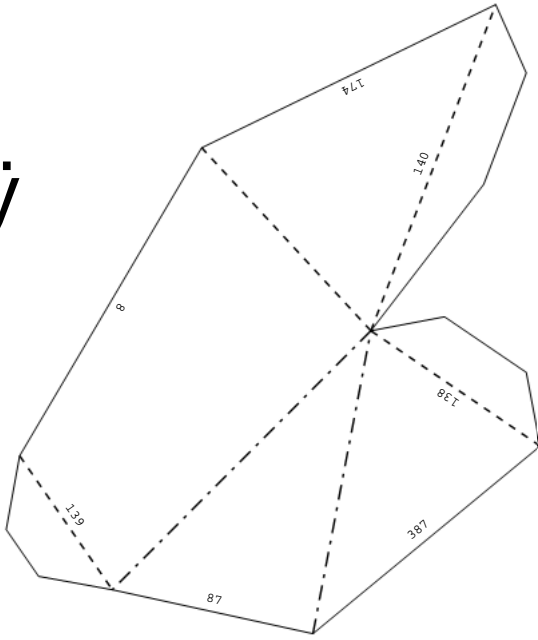

# Øiåløå

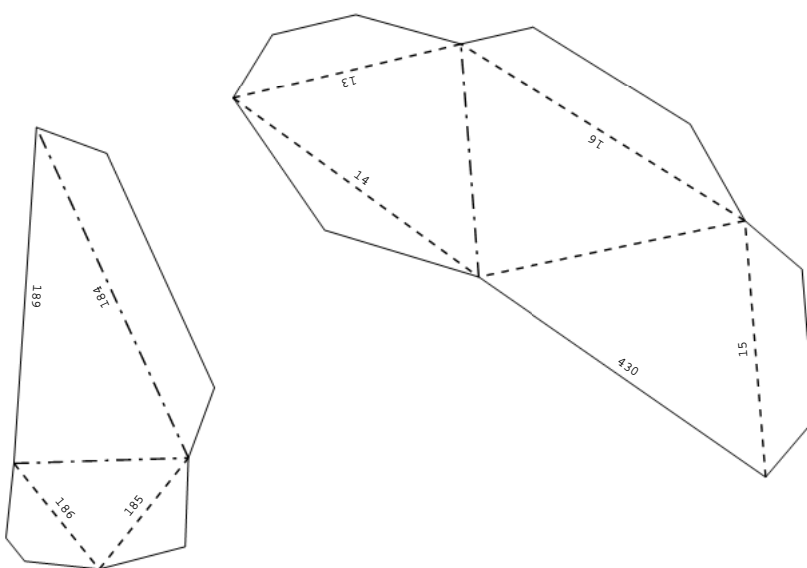
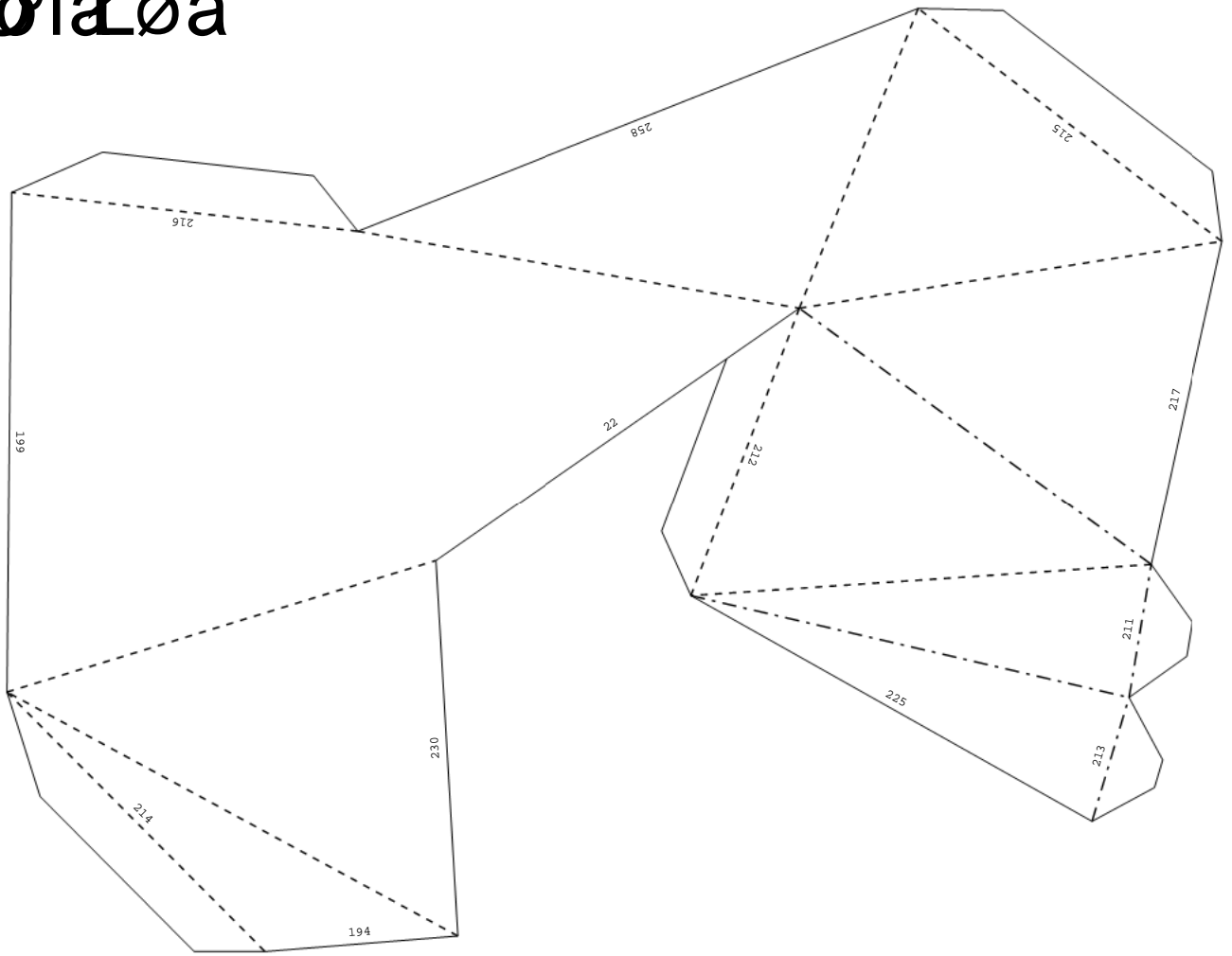

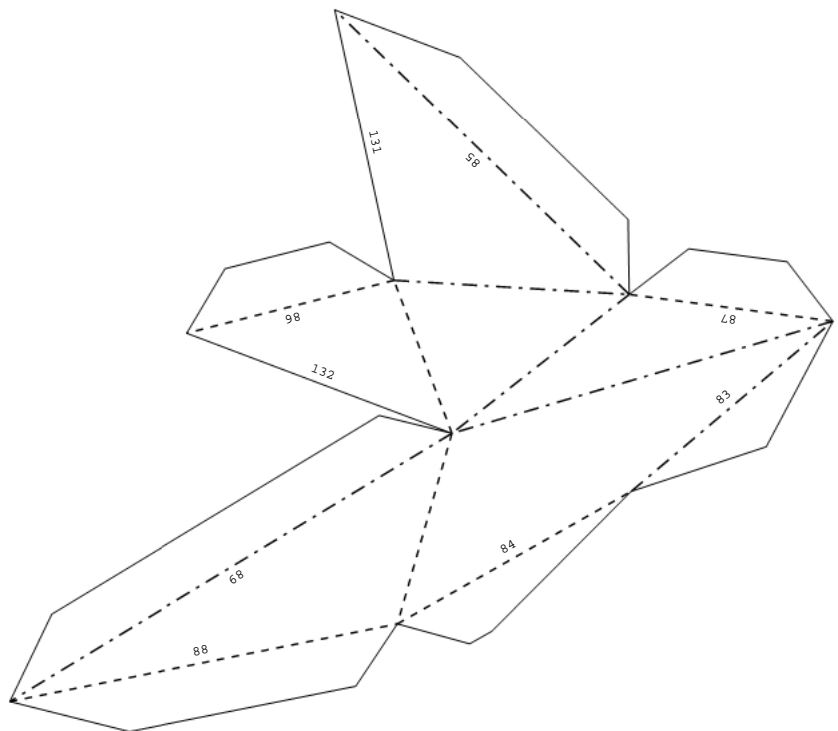
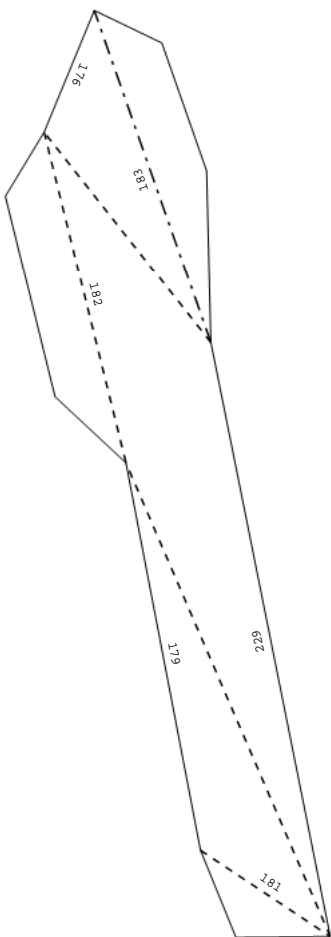
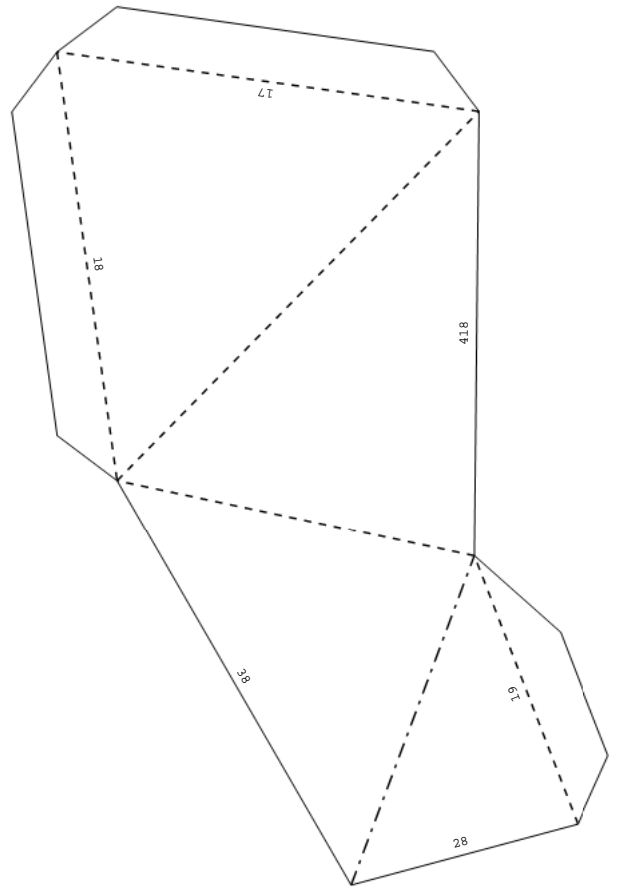
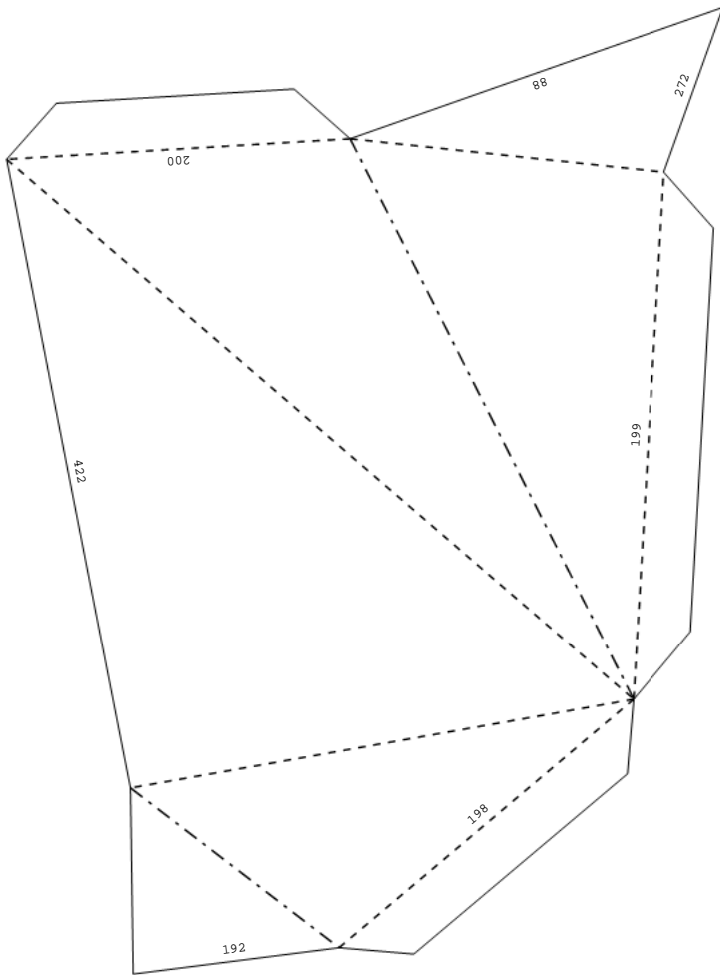

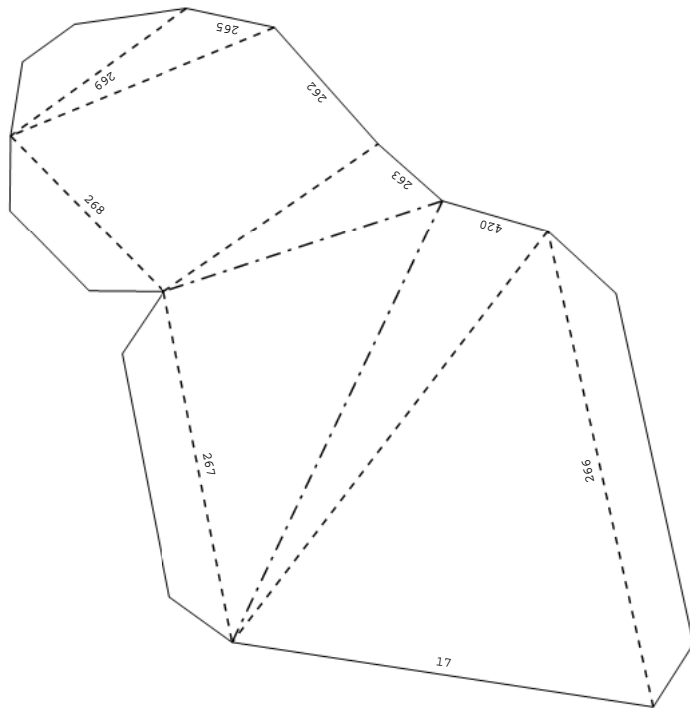
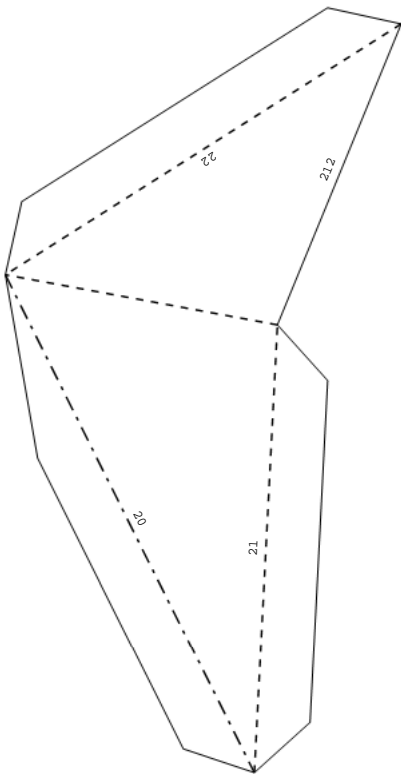
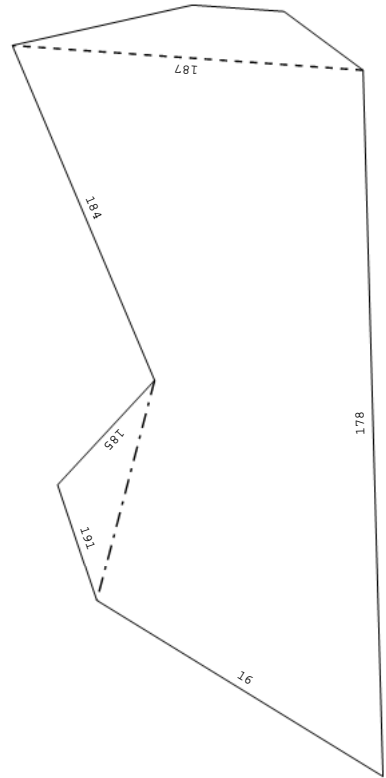
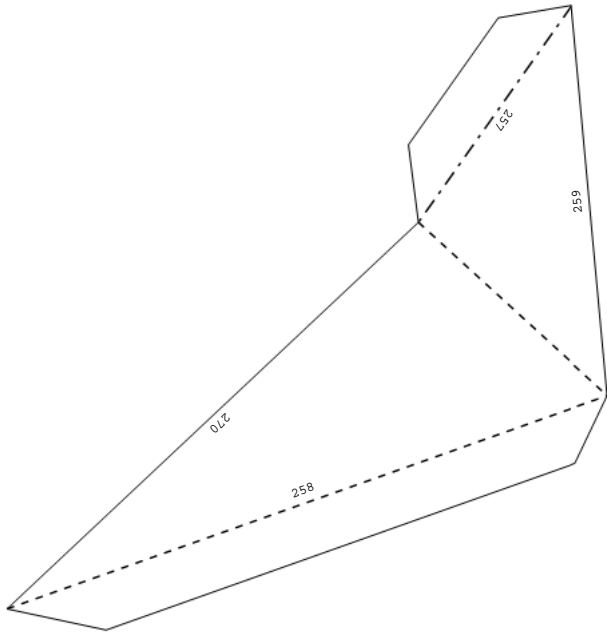



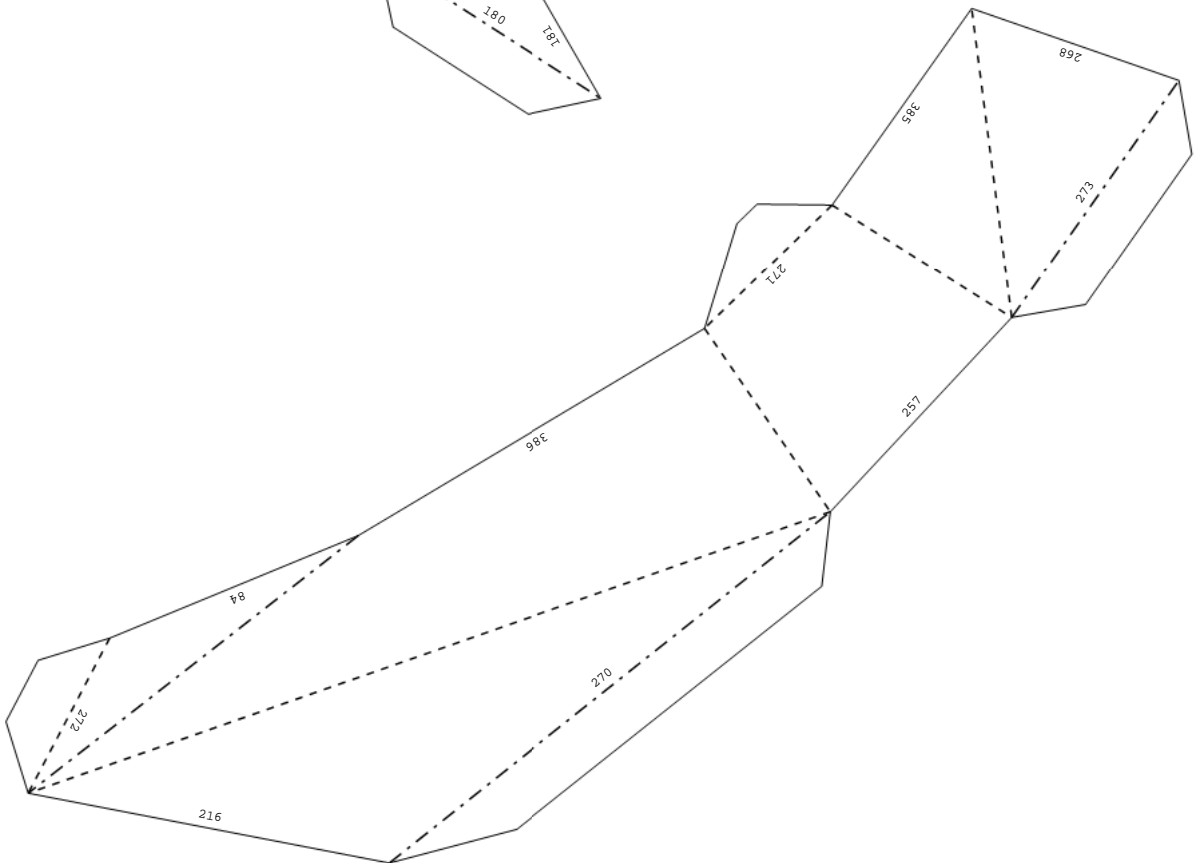
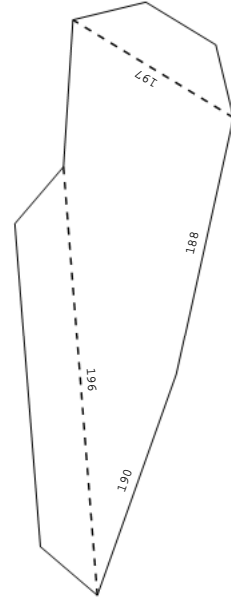
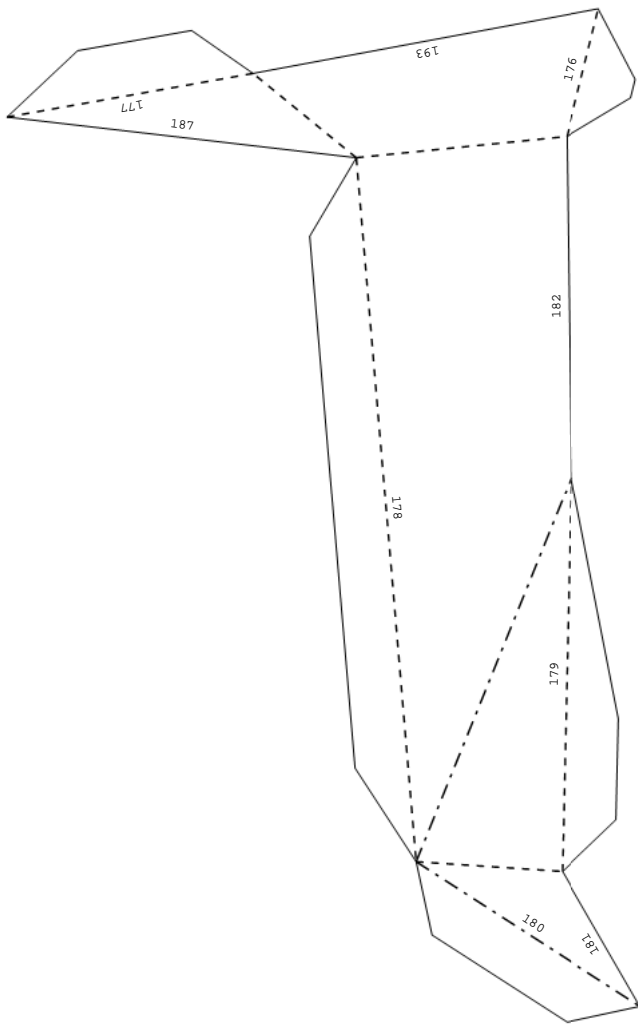

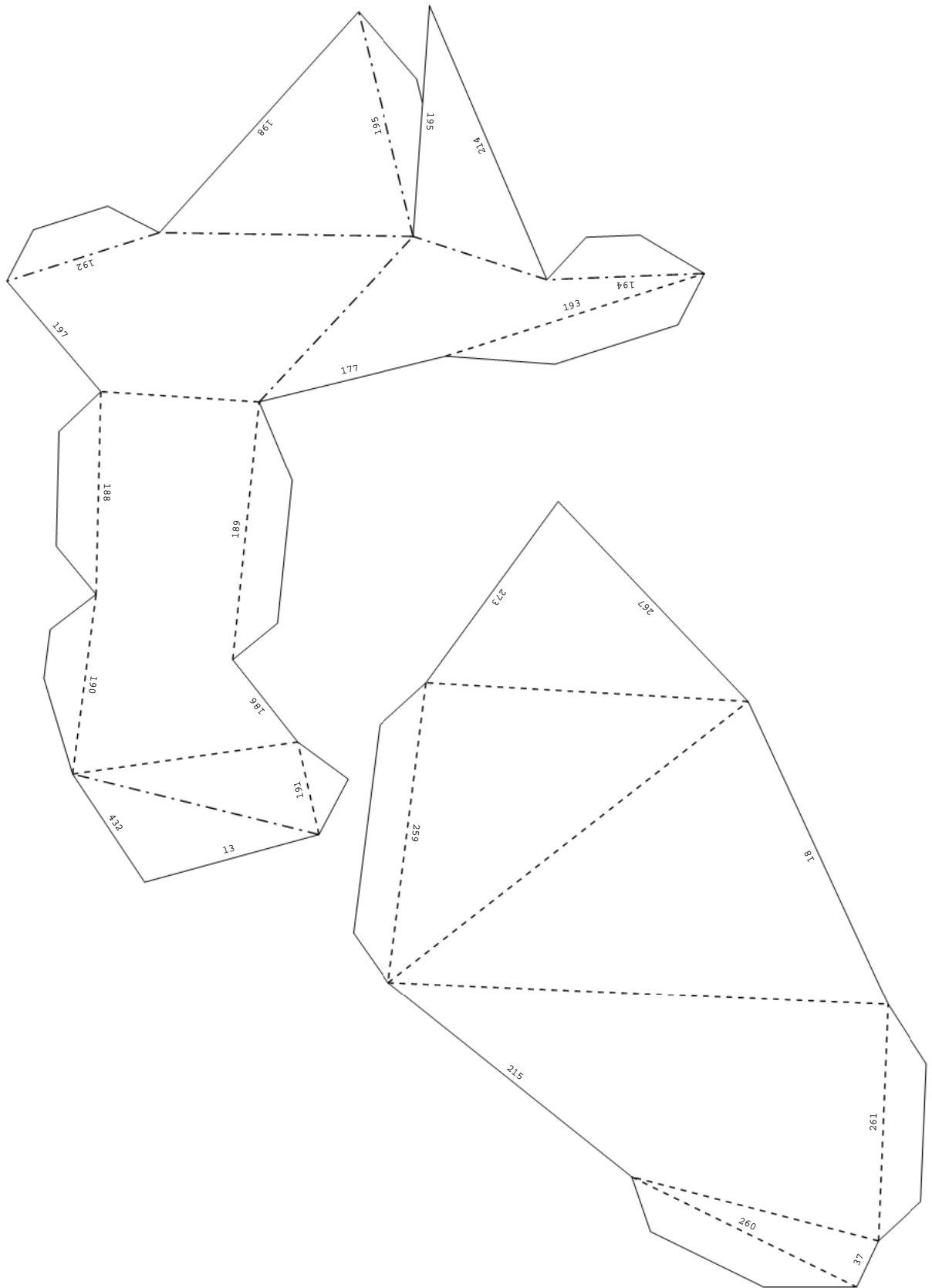

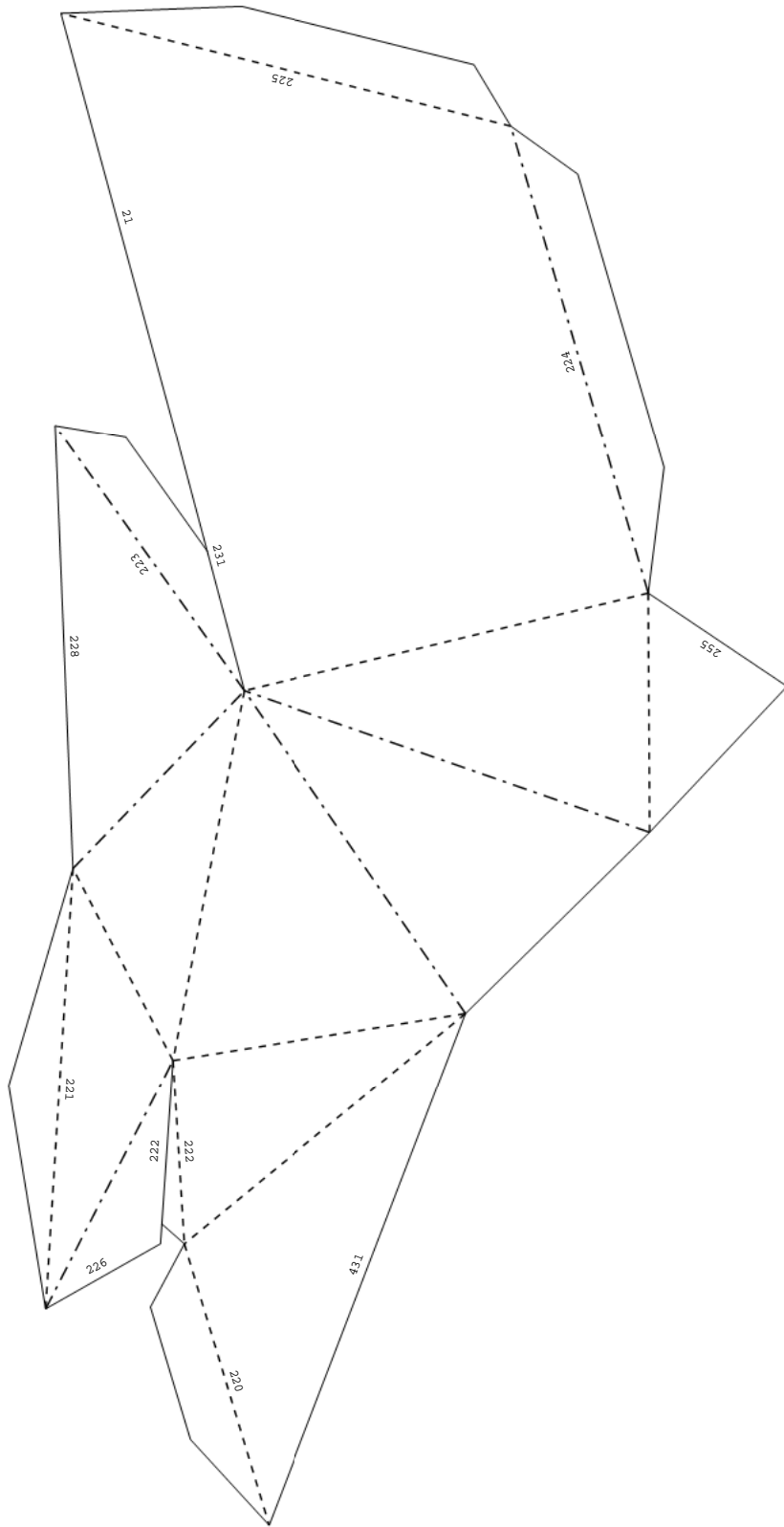

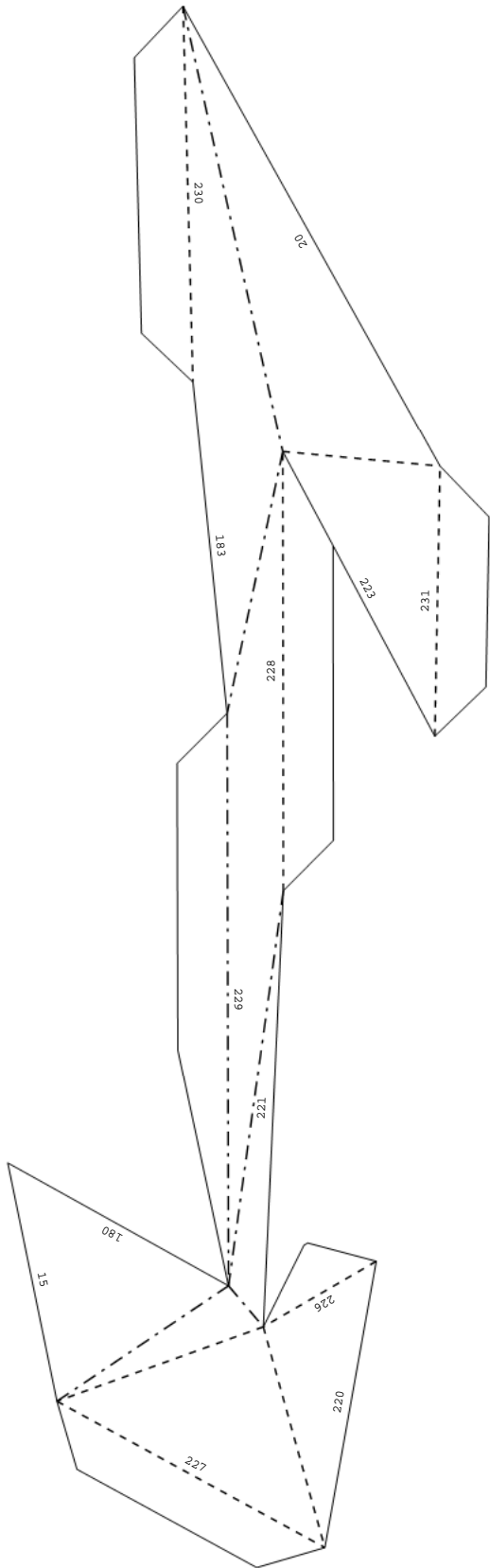

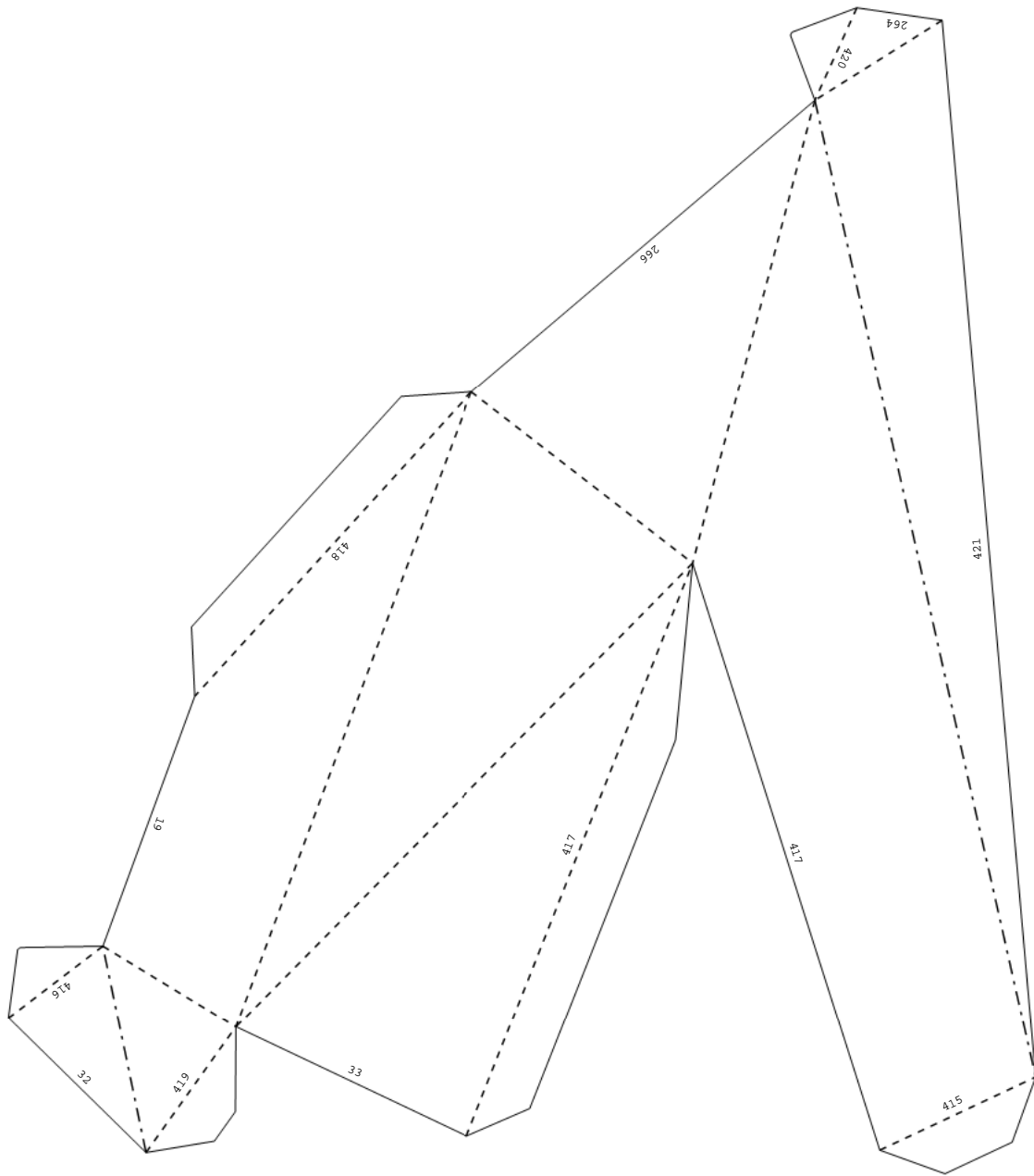

—óEà

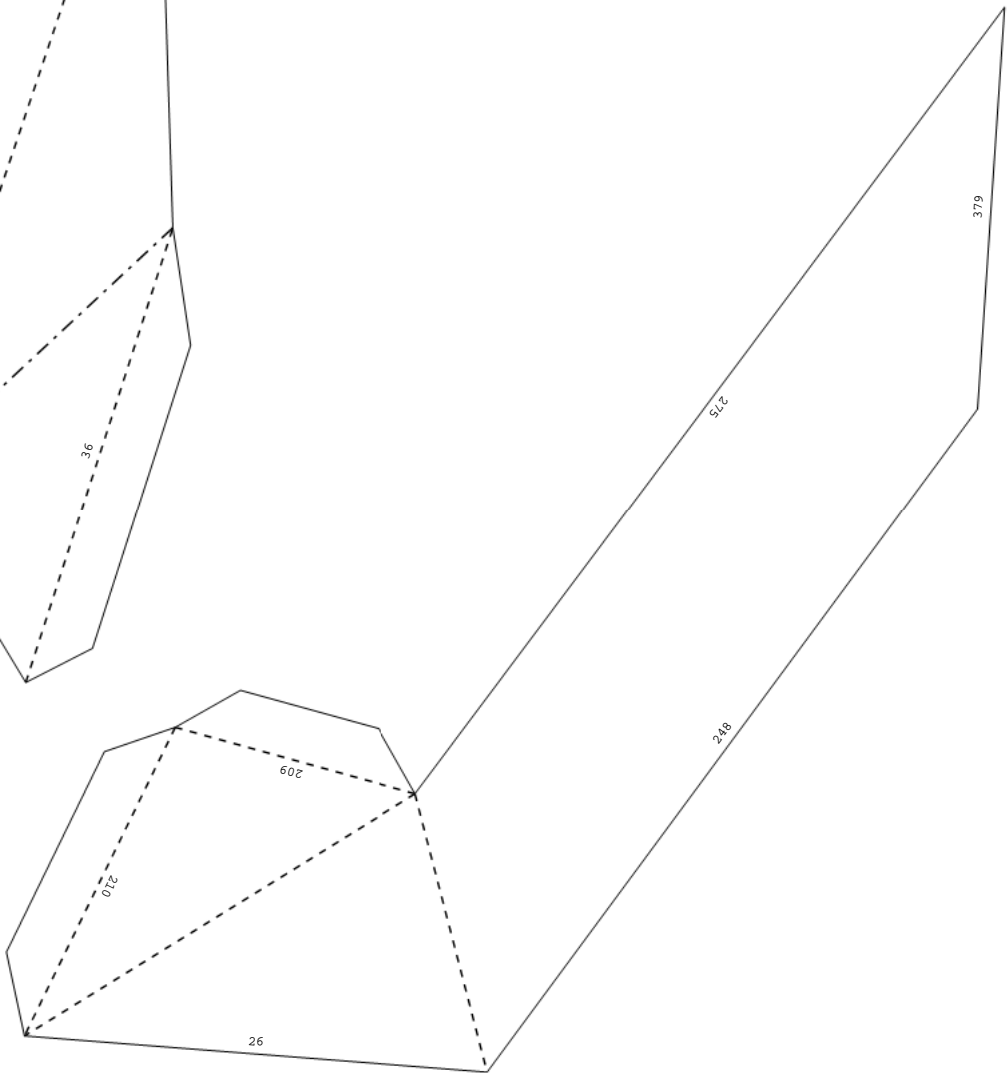
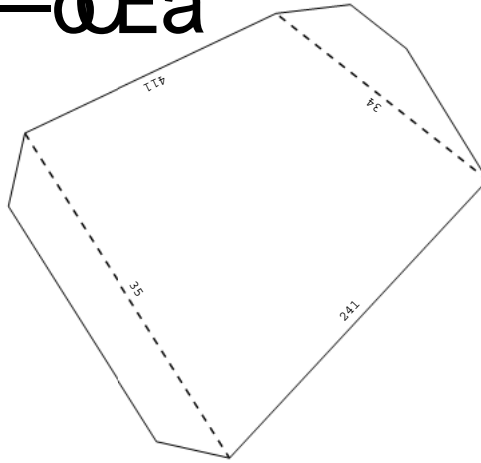
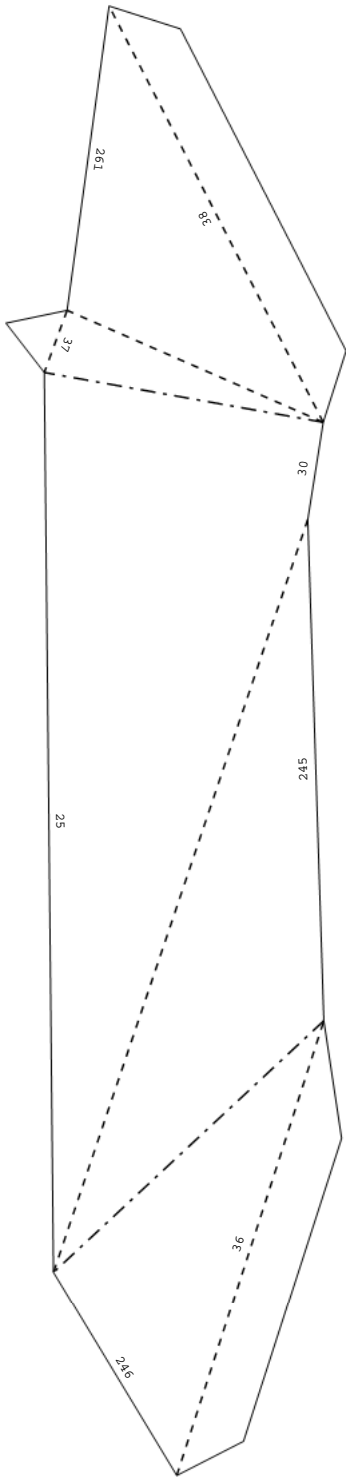

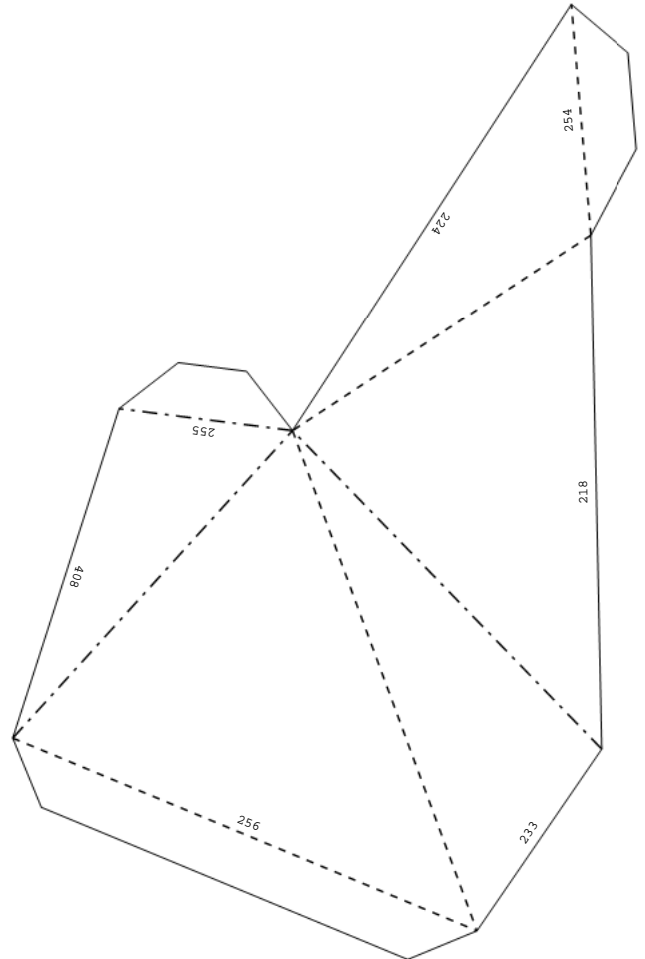
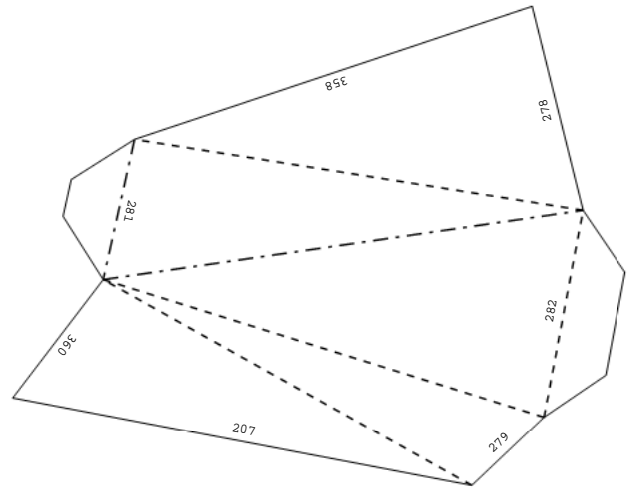
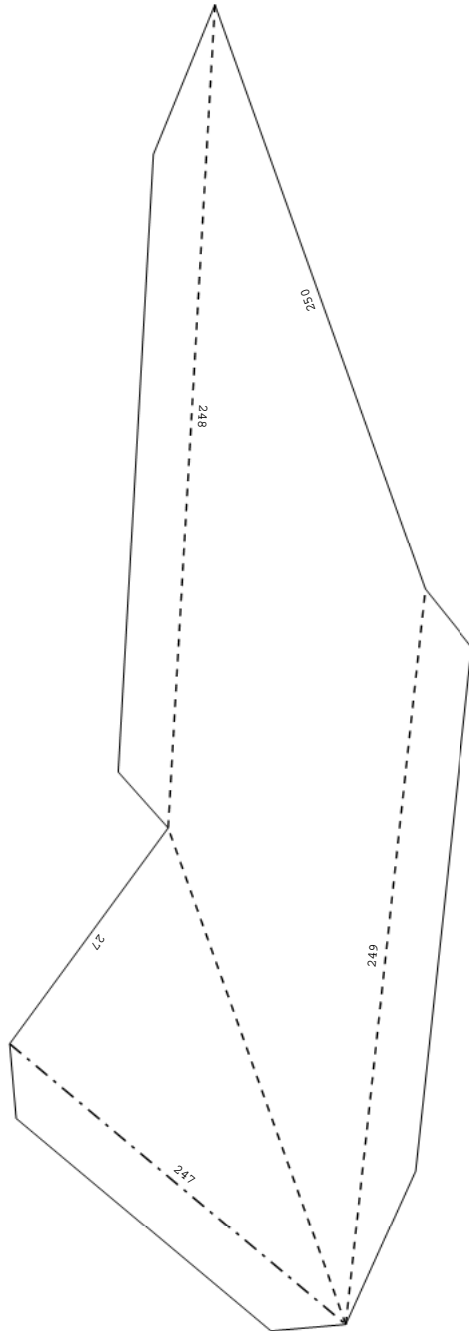

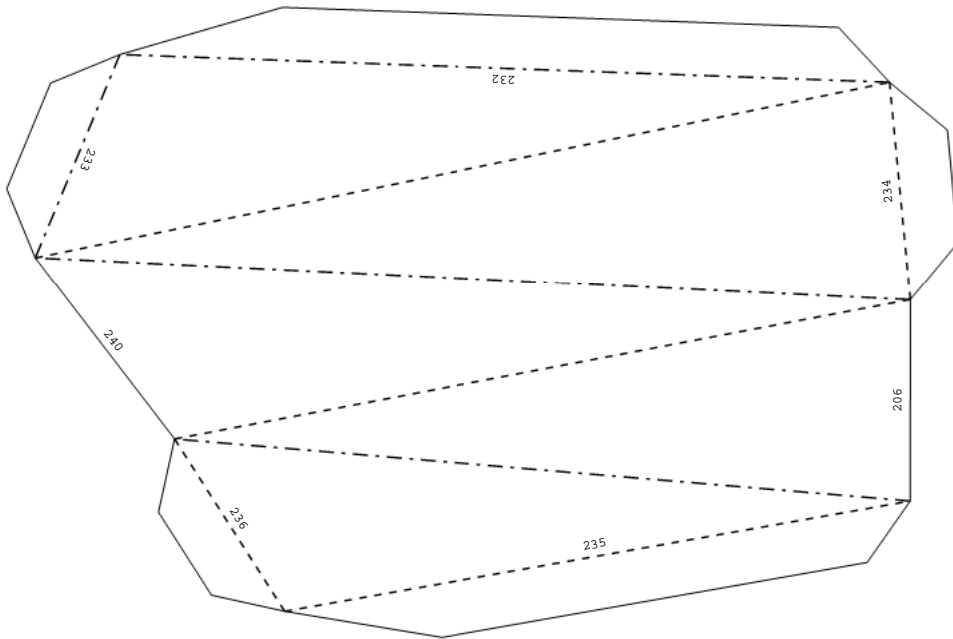
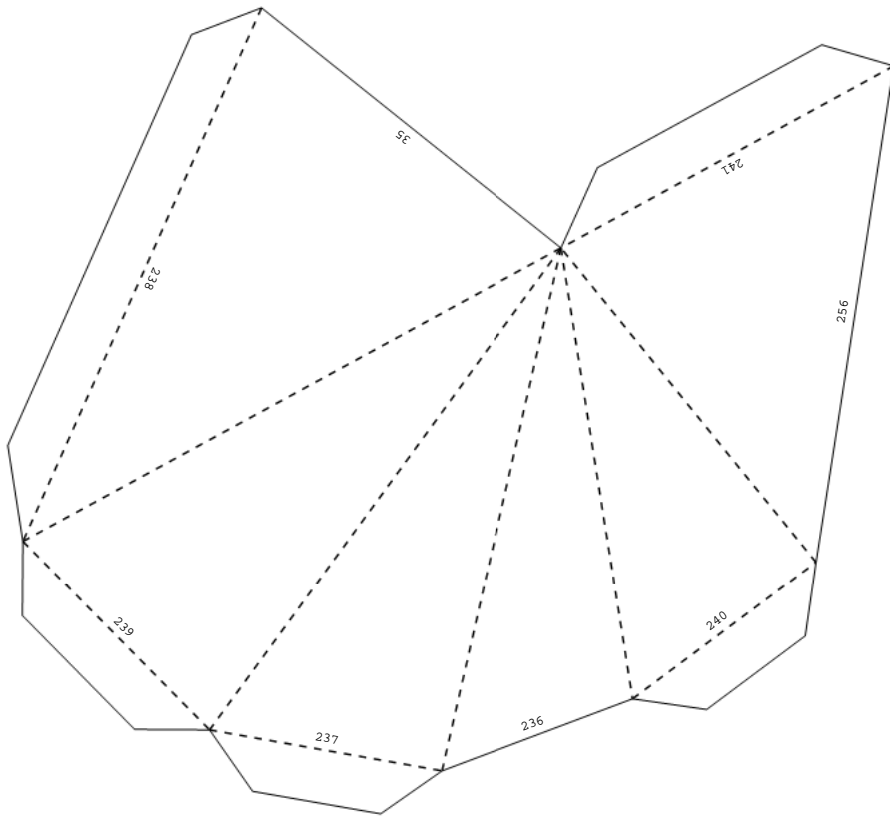



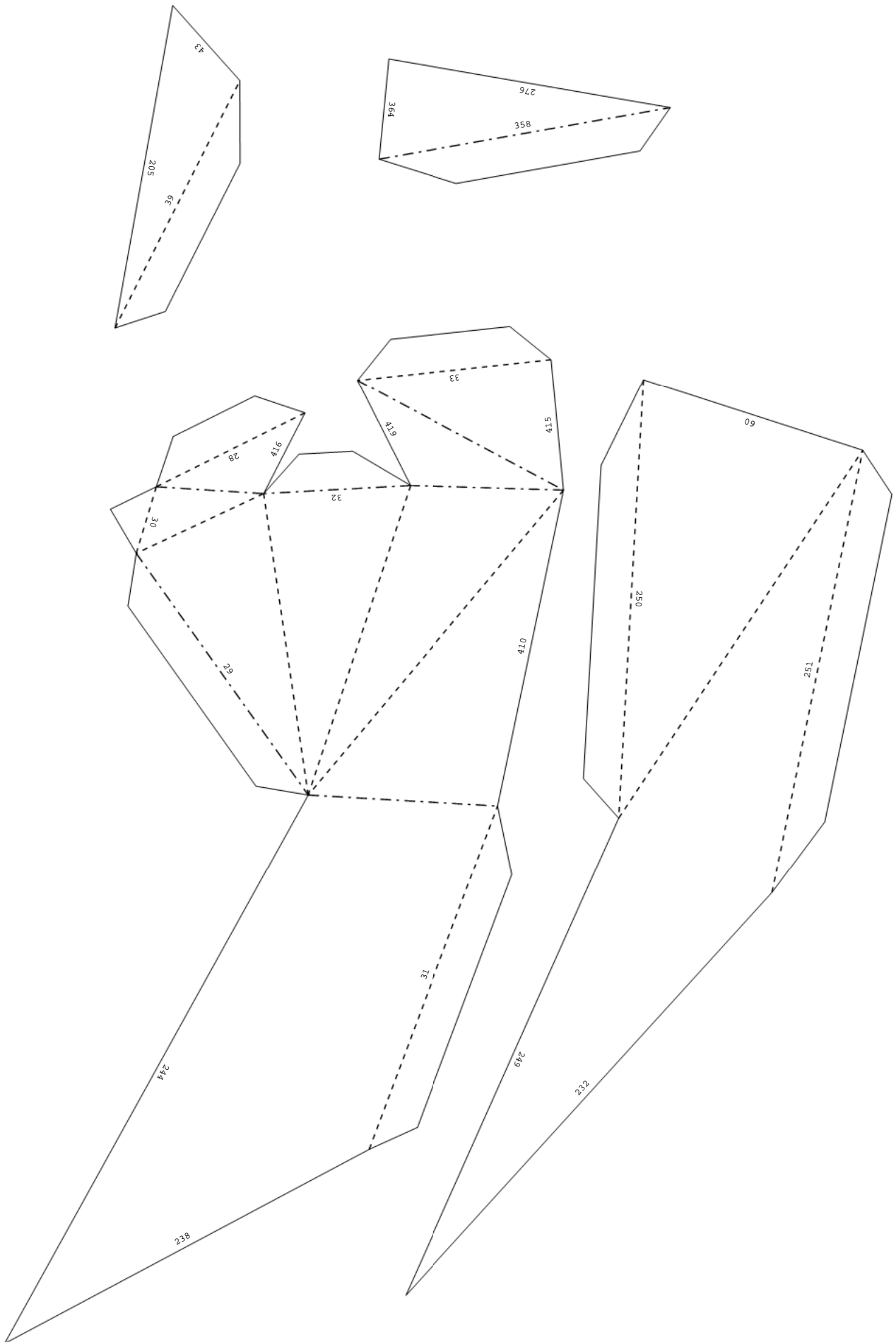

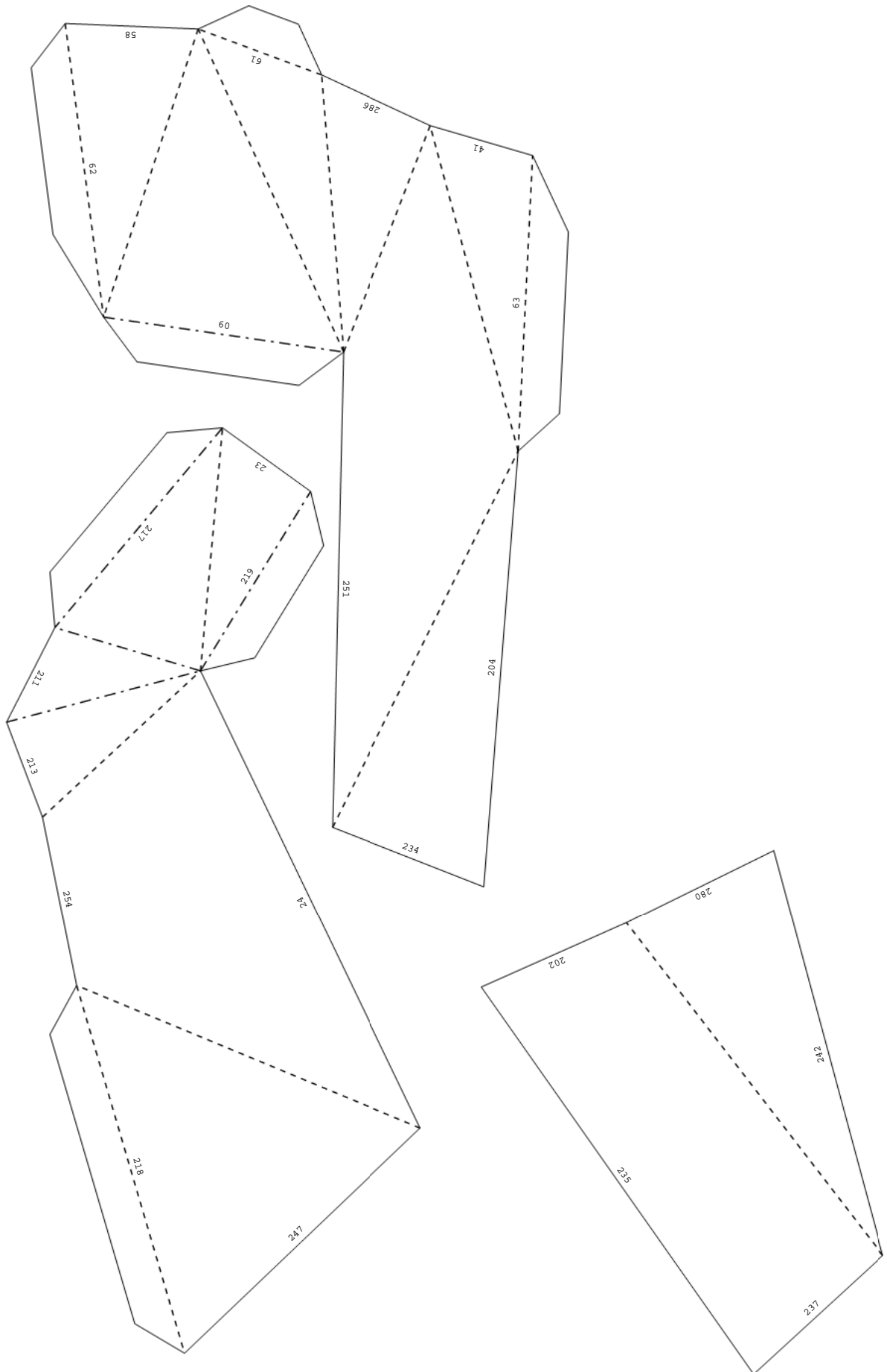

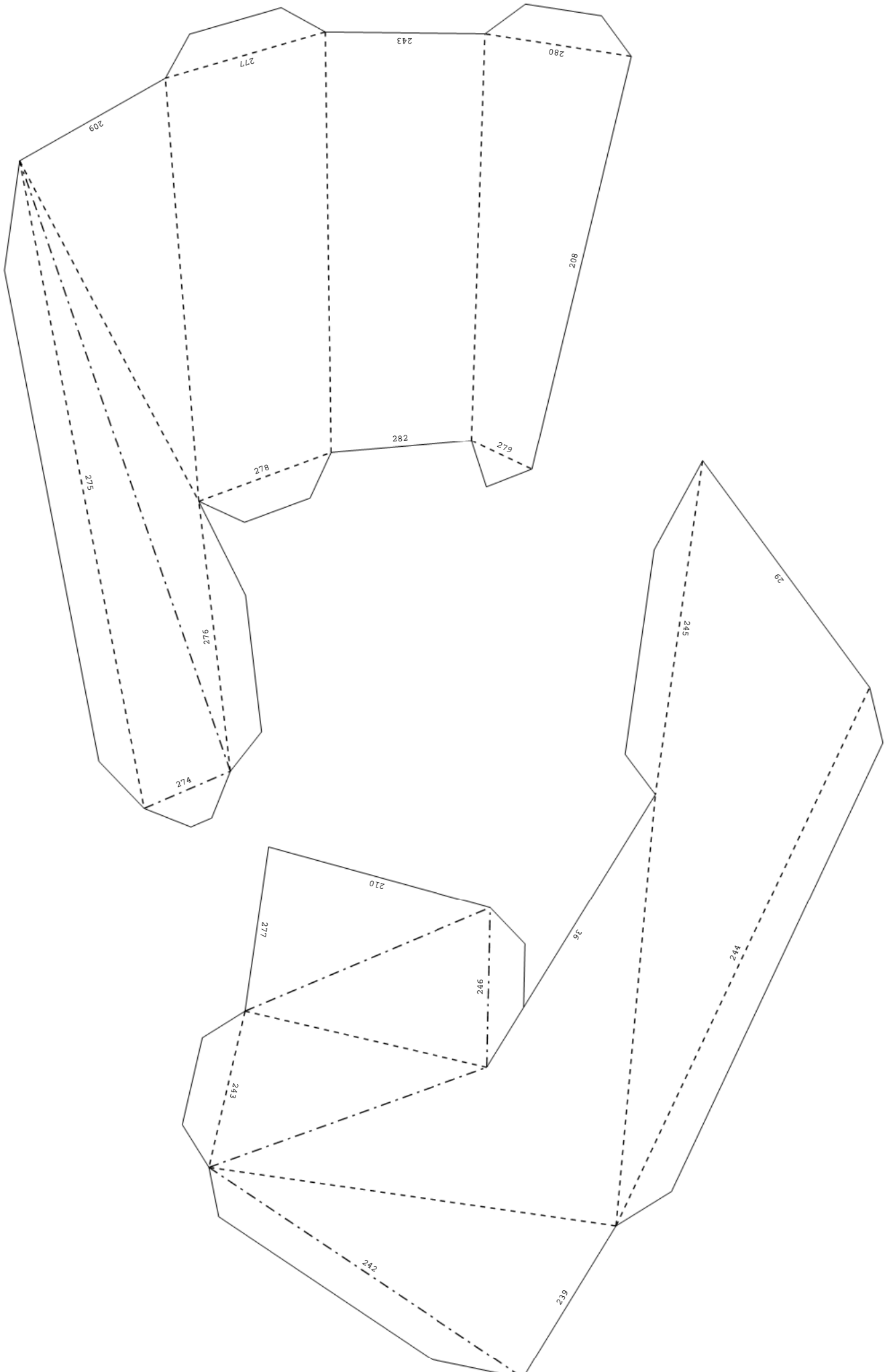

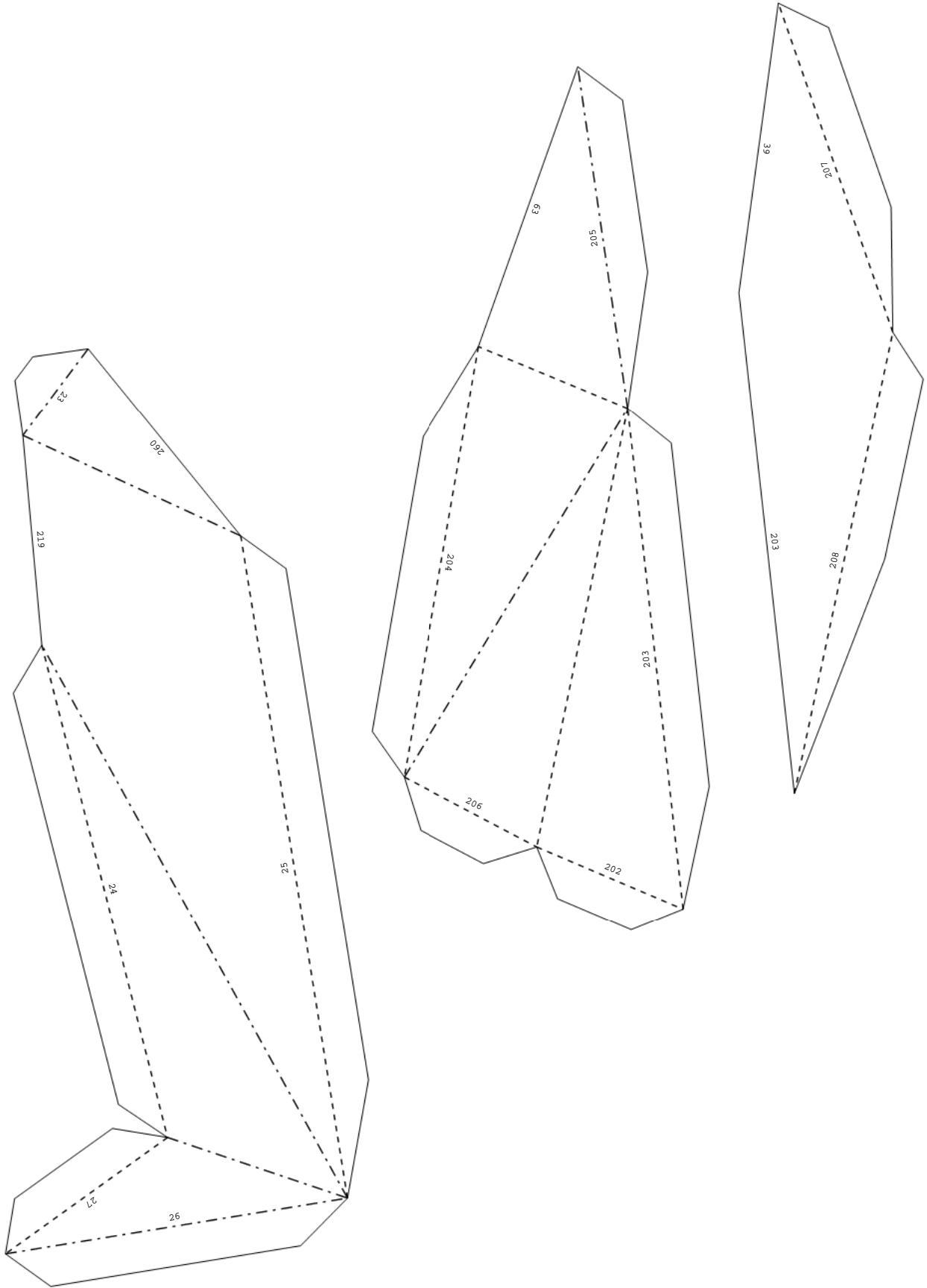



# °Łæüü

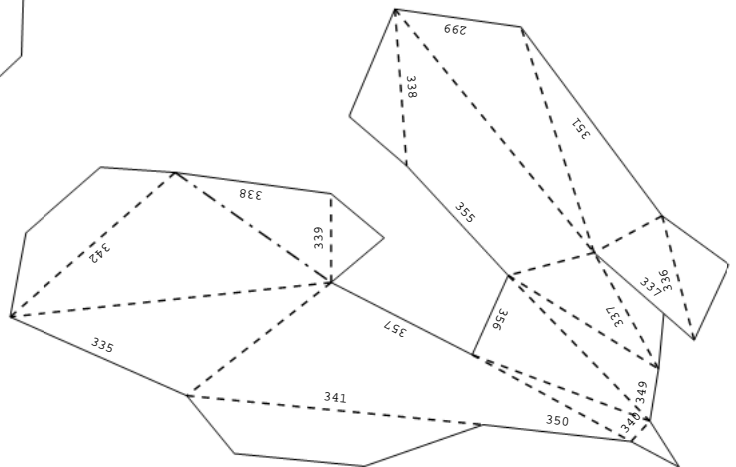
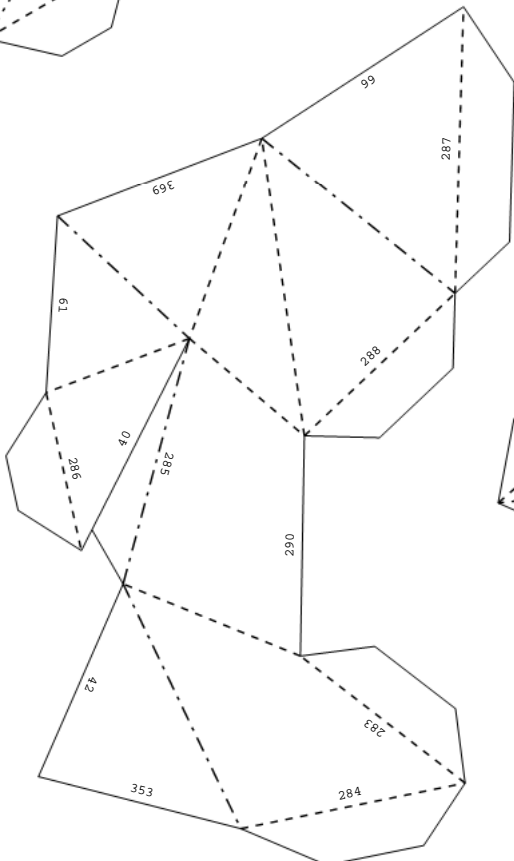
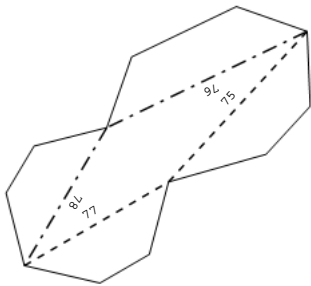
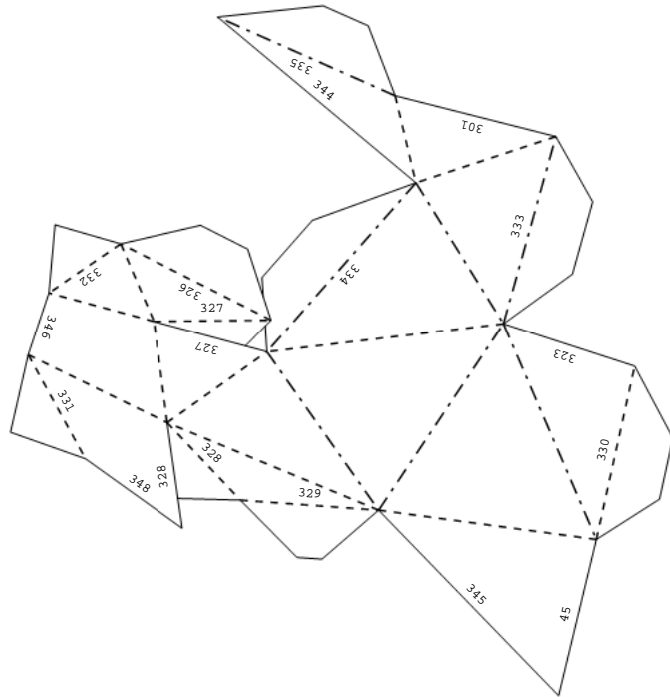
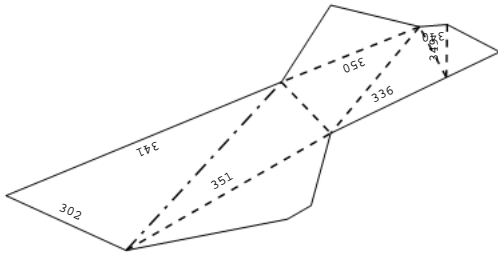

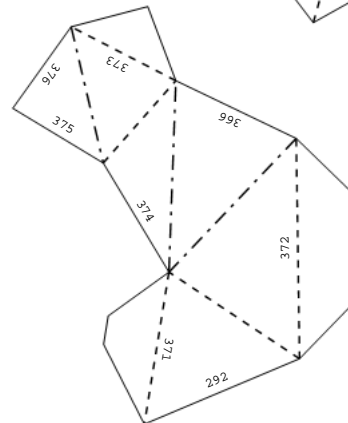
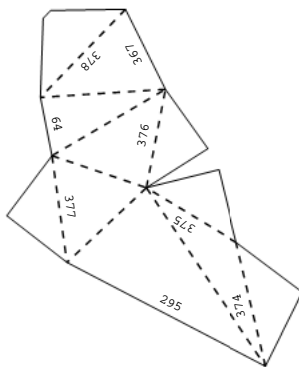
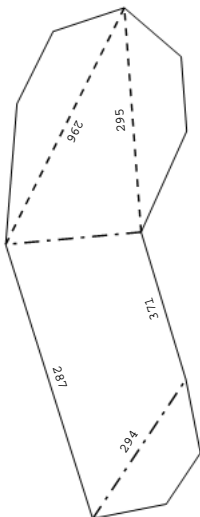
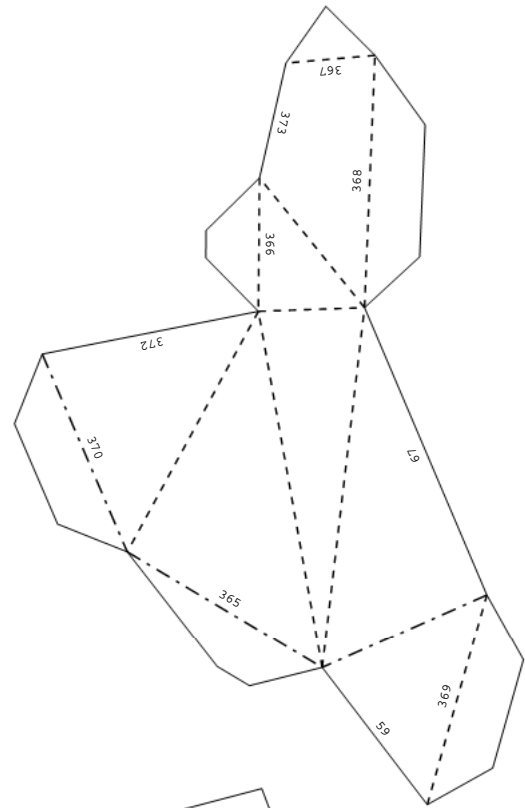
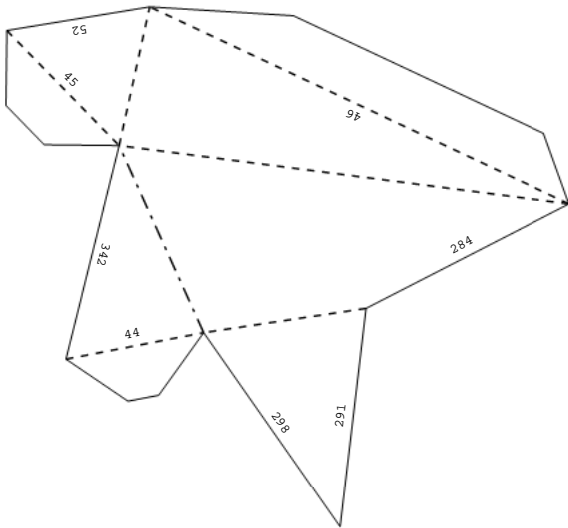
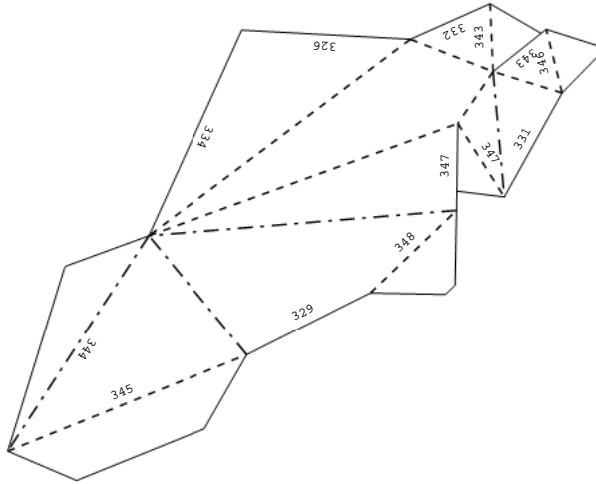
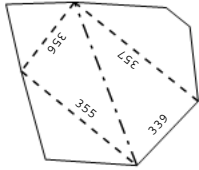
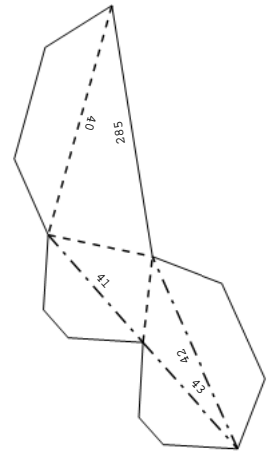
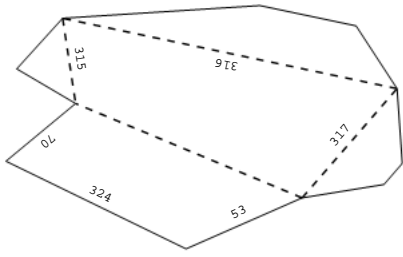

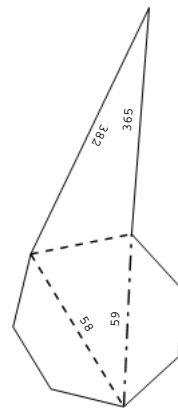
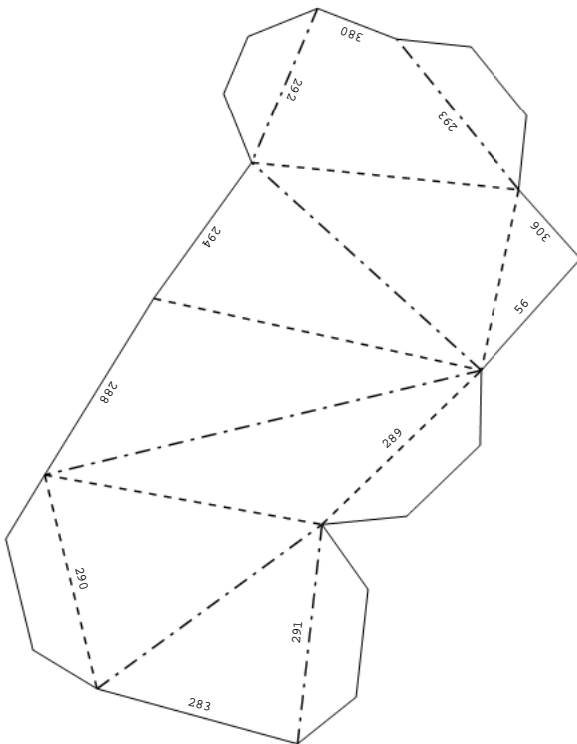
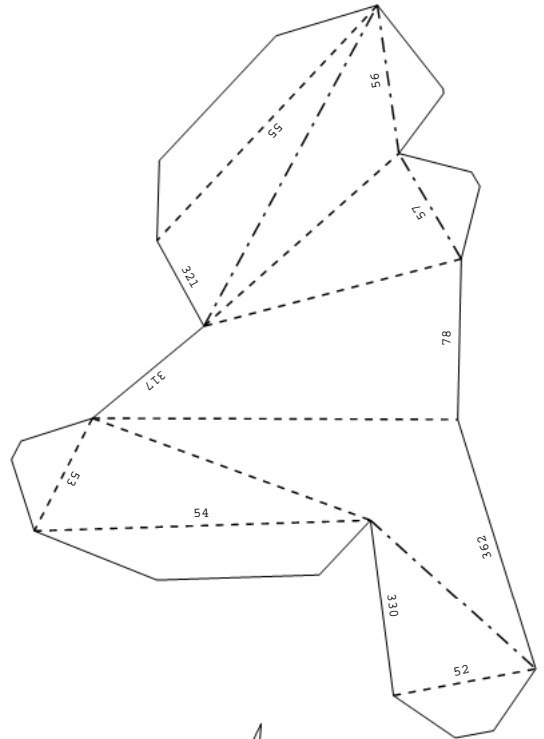
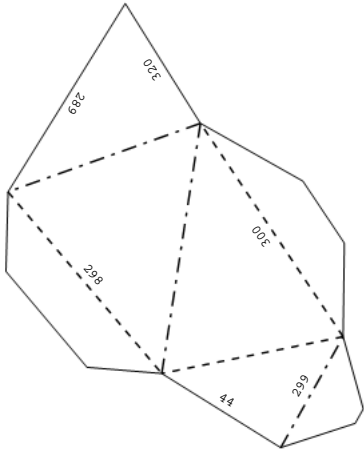
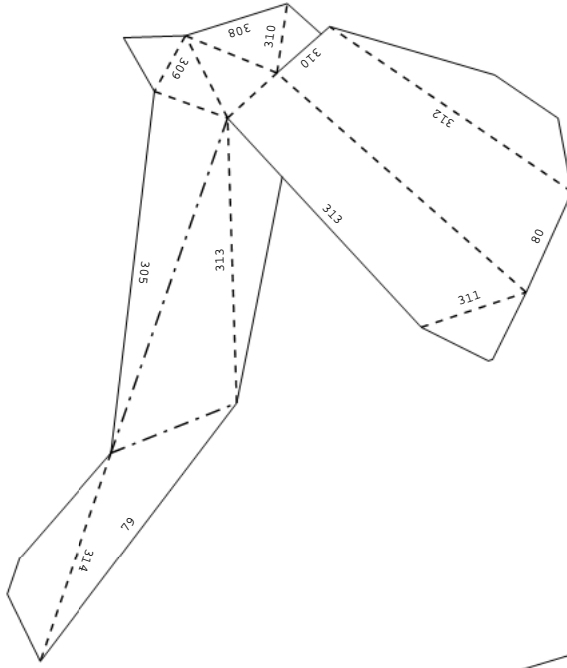
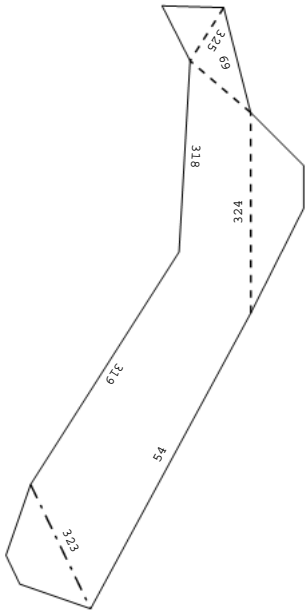

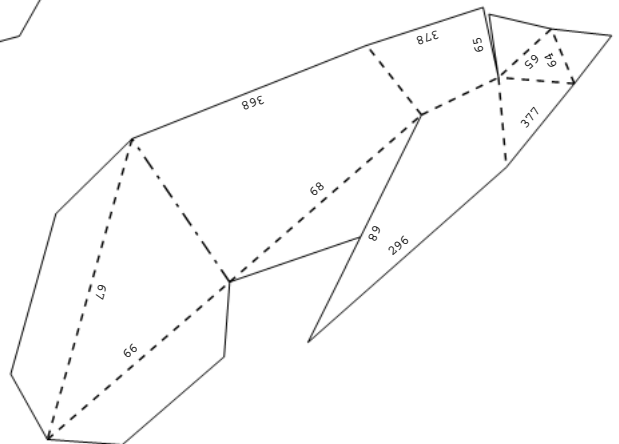
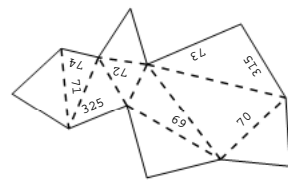
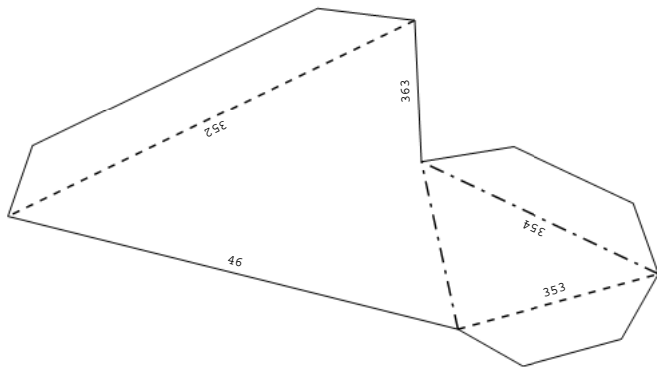
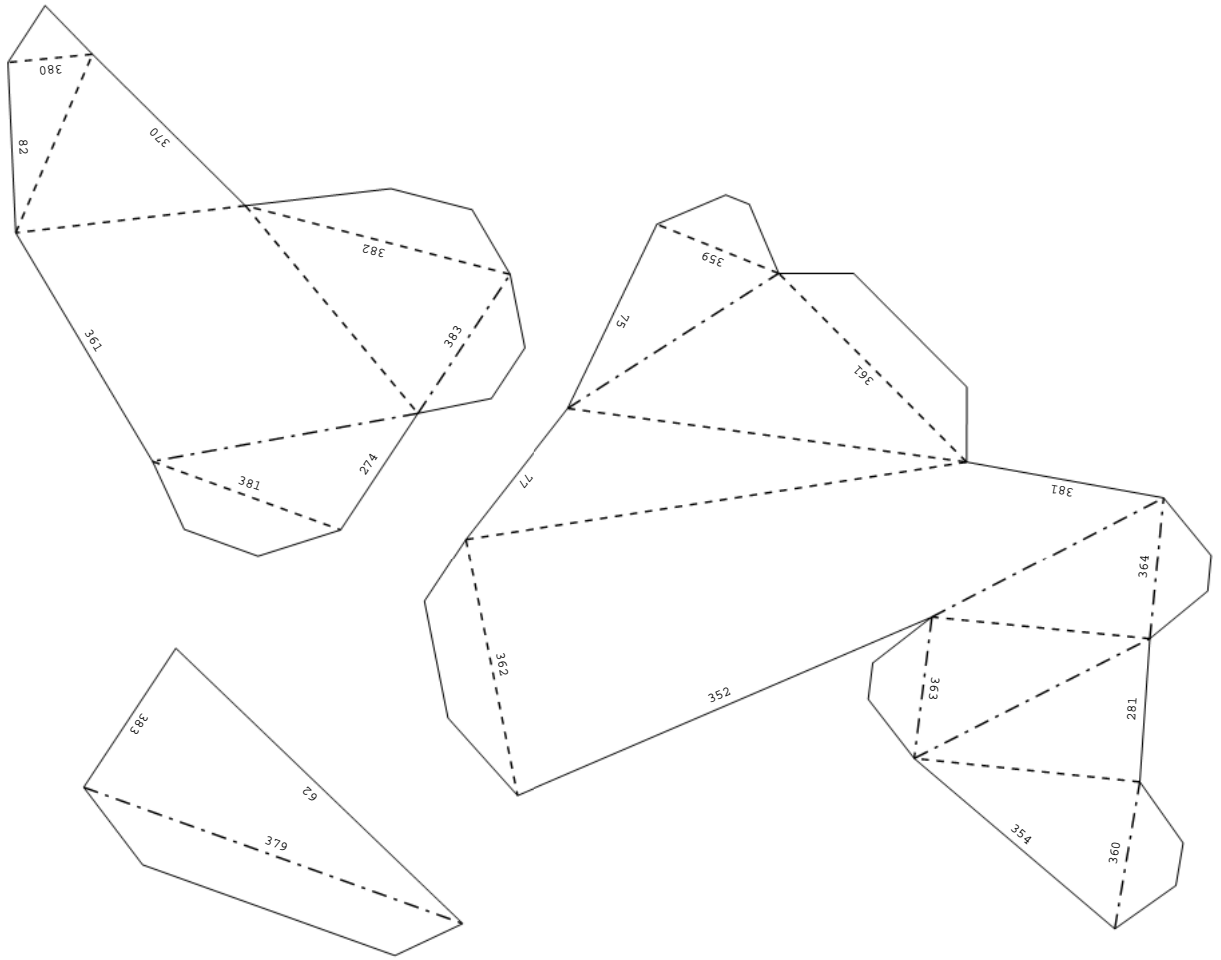



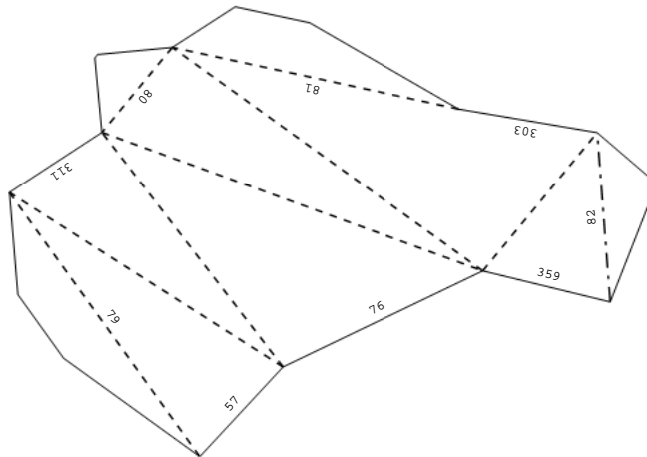
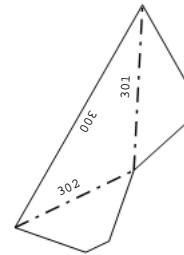
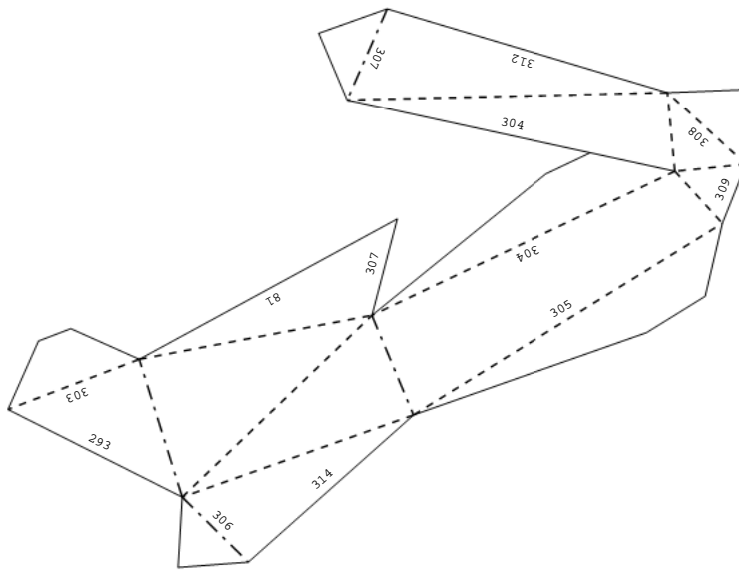
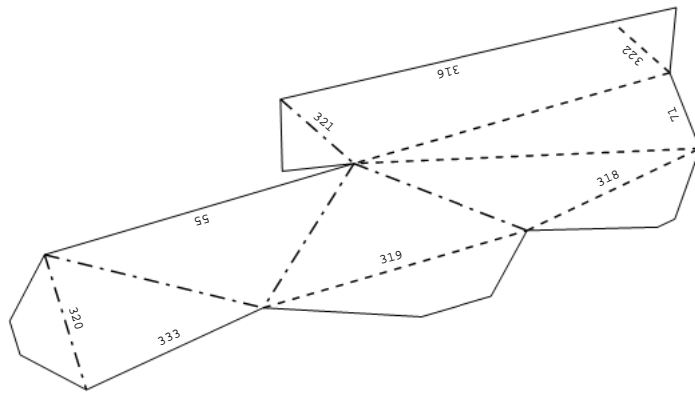

· äÿæǎŒà

